

Burner Systems:

- G10-16/18(P)
- G10-16/18-12(M)(P)
- G10-16/18-15(M)(P)
- G10-16/18-01V(P)

For indoor stainless steel models;
 add (-SS) to end of model #



**DESIGN CERTIFIED
 to standards:**

**Unvented Room Heater
 ANSI Z21.11.2-2007**

and

**Vented Decorative Appliance
 ANSI Z21.60b-2004**

Log Sets:

- CHAS-16/18 Charred Aged Split Oak
- CHFR-16/18 Charred Frontier Oak

G10-16/18 SERIES UNVENTED GAS LOG SETS

INSTALLER: Leave this manual with the appliance
CONSUMER: Retain this manual for future reference

Installation and service must be performed by a qualified professional installer, service agency, or the gas supplier.

⚠ WARNING: If the information in this manual is not followed exactly, a fire or explosion may result, causing property damage, personal injury, or loss of life.

Do not store or use gasoline or other flammable vapors and liquids in the vicinity of this or any other appliance.

WHAT TO DO IF YOU SMELL GAS:

- Open a window.
- Do not try to light any appliance.
- Do not touch any electrical switch; do not use any phone in your building.
- Immediately call your gas supplier from a neighbor's phone. Follow the gas supplier's instructions.
- If you cannot reach your gas supplier, call the fire department.

It is imperative that you maintain your unvented gas appliance by having it cleaned and serviced regularly. See pages 11, 22 & 23 for details.

Important

Read these instructions carefully and completely before starting installation of the burner system.

This appliance may be installed in an aftermarket, permanently located, manufactured (mobile) home where not prohibited by local codes.

This appliance is only for use with the type of gas indicated on the rating plate. This appliance is not convertible for use with other gasses.

This is an UNVENTED gas-fired heater. It uses air (oxygen) from the room in which it is installed. Provisions for adequate combustion and ventilation air MUST be provided. See section entitled VENTILATION AND CONFINED SPACE INFORMATION.

This appliance is designed as an **attended appliance**. Adults must be present when the unit is operating. Do not leave this unit burning when unattended or while anyone is sleeping.

Installation, service, and the provisions for combustion and ventilation air MUST conform with local codes and with the *National Fuel Gas Code*, ANSI Z223.1/ NFPA 54, or the CSA B149.1, *Natural Gas And Propane Installation Code*.



TABLE OF CONTENTS

| | |
|----|--|
| 2 | TABLE OF CONTENTS |
| 3 | SPECIFICATIONS AND REQUIREMENTS |
| 4 | IMPORTANT SAFETY INFORMATION |
| 5 | VENTILATION AND CONFINED SPACE SAFETY INFORMATION |
| 6 | MINIMUM CLEARANCES TO COMBUSTIBLES |
| 8 | PRE-INSTALLATION AND FIREPLACE PREPARATION SAFETY |
| 9 | INSTALLATION SAFETY INFORMATION |
| 9 | INSTALLATION SAFETY GUIDELINES |
| 10 | OPERATIONAL SAFETY INFORMATION |
| 11 | CLEANING AND SERVICING IMPORTANT INFORMATION |
| 12 | LOGS - PARTS LIST |
| 13 | BURNER PARTS LIST FOR 15 SERIES VALVE |
| 14 | BURNER PARTS LIST FOR MANUAL VALVE |
| 15 | BURNER PARTS LIST FOR 12 SERIES VALVE |
| 16 | BURNER PARTS LIST FOR 01V SERIES VALVE |
| 17 | WHEN USED AS A VENTED DECORATIVE APPLIANCE (PER ANSI Z21.60b-2004) |
| 17 | INSTALLATION - CONNECTING THE GAS TO THE BURNER SYSTEM |
| 18 | INSTALLATION |
| 18 | CONTROL SETTINGS |
| 19 | INSTALLATION - CHECKING GAS PRESSURE |
| 19 | CHECKING GAS PRESSURE |
| 20 | INSTALLATION - GRANULE, EMBER AND LOG PLACEMENT |
| 21 | INSTALLATION - LOG PLACEMENT |
| 22 | INSTALLATION: DAMPER CLAMP (IF APPLICABLE) |
| 22 | CLEANING AND SERVICING SAFETY INFORMATION |
| 23 | CLEANING AND SERVICING |
| 23 | TO CLEAN THE LOG SET |
| 23 | CLEANING AND SERVICING THE ODS PILOT |
| 24 | OPERATING THE UNVENTED GAS LOG SET |
| 24 | CHECKING THE ODS PILOT FLAME APPEARANCE |
| 25 | LIGHTING INSTRUCTIONS - SERIES 15 VALVE |
| 26 | LIGHTING INSTRUCTIONS - MANUAL VALVE |
| 27 | LIGHTING INSTRUCTIONS - SERIES 12 VALVE |
| 28 | LIGHTING INSTRUCTIONS - 01V(P) VALVE |
| 29 | TROUBLESHOOTING |
| 32 | WARRANTY |

SPECIFICATIONS AND REQUIREMENTS

WARNING: This appliance is for installation only in a:

1. Solid-fuel-burning masonry or UL-127 factory-built fireplace, or
2. Listed ventless firebox enclosure.

It has been designed certified for these installations. Exception: DO NOT install this appliance in a factory built fireplace that includes instructions stating it has not been tested or should not be used with unvented gas logs.

Note: Installation in any other fireplace is prohibited and will void any approvals and warranties.

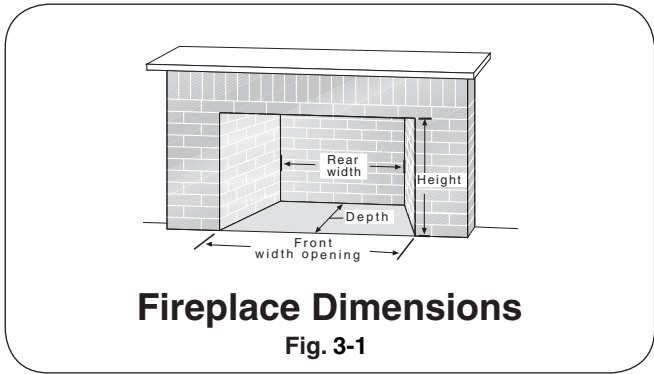

Any installation of this appliance is subject to minimum fireplace size requirements below:

| Burner Model | Minimum Fireplace Size (refer to Fig. 3-1) | | | BTU Input Rating | | | |
|------------------|---|-------|--------|------------------|-------------|-------------|-------------|
| | Width | Depth | Height | High Setting | | Low Setting | |
| | | | | Natural Gas | Propane Gas | Natural Gas | Propane Gas |
| G10-16/18 | 22" front 20" rear * | 13" | 18" | 35k | 32k | 26k | 24k |

* based on minimum depth

The G10 Series vent-free gas log sets are available with a manual ODS pilot, an on-off remote, or a variable flame height control valve that can be used with the remote transmitter and receiver.

A spark ignition system (piezo) allows the gas pilot to be lit without the use of matches, and permits the operation of the appliance during a power outage.

This burner system is equipped with an Oxygen Depletion Sensor (ODS) safety pilot system. The ODS senses the amount of oxygen available in the room and shuts the burner system off before the oxygen level drops below 18%. The pilot can only be relit when fresh air is available. **This may require opening a window or a door to another room or cracking the damper open slightly.**

This gas log set has been certified to two standards:

UNVENTED ROOM HEATER-ANSI Z21.11.2-2007

VENTED DECORATIVE APPLIANCE-ANSI Z21.60b-2004

Check local or state codes to determine if vent-free heaters are permitted in your area before you install this log set as a vent-free appliance. If not permitted, you may install and operate this log set as a vented appliance.

This unit may not be installed in a vented fireplace with a chimney of less than 15 feet in height.

Observing minimum fireplace dimensions and centering the appliance in the fireplace will assure adequate clearance for operation and servicing. It may be necessary to disconnect the unit for some types of service.

Minimum Permanent Chimney Vent Opening in sq. in. (when used as a vented appliance)

| Table 3-1 Chimney Height | Factory built fireplaces | Masonry built fireplaces |
|-----------------------------|--------------------------|--------------------------|
| 15' | 22 | 17 |
| 20' | 20 | 15 |
| 25' | 19 | - |
| 30' | 18 | 13 |

Important: For safe operation and proper performance of this product and to comply with certification, listings, and building code acceptances, use ONLY Peterson Real-Fyre® controls, parts, and accessories that have been specifically listed or certified for use with this burner system. Use of other controls, parts, or accessories is prohibited and will void all warranties, certifications, listings, and building code approvals, and may cause property damage, personal injury, and loss of life.

IMPORTANT SAFETY INFORMATION

ANSI Z21.11.2-2007 UNVENTED ROOM HEATER GENERAL SAFETY INFORMATION

A. **WARNING: CARBON MONOXIDE POISONING MAY LEAD TO DEATH.**

When used without fresh air, gas appliances may give off carbon monoxide, an odorless, colorless, poisonous gas. Early signs of carbon monoxide poisoning are similar to the flu, with headaches, dizziness, and/or nausea. If you have these signs, the gas appliance may not be installed correctly, or may not be working properly. **GET FRESH AIR AT ONCE! STOP USING THE APPLIANCE IMMEDIATELY!** Have the appliance serviced before use continues. Some people, including pregnant women; persons with heart or lung disease, asthma, or anemia; those under the influence of alcohol; and persons at high altitudes, are more affected by carbon monoxide than others.

If there are **ANY** signs of carbon monoxide, **GET FRESH AIR AT ONCE! STOP USING THIS APPLIANCE IMMEDIATELY!**

- B. If any soot appears on the appliance or other areas of the fireplace in which this appliance is installed, shut system off and call a qualified professional service technician, **vent-free gas burner system technician**, or your local gas company.
- C. This appliance may be installed in an aftermarket, permanently located, manufactured (mobile) home where not prohibited by local codes. Installation of appliances designed for manufactured homes or mobile homes must conform with the *Manufactured Home Construction and Safety Standard, Title 24 CFR, Part 3280* in the U.S.; or with *CAN/CSA Z240 MH, Mobile Housing in Canada*; or with *ANSI/NCSBCS A225.1/NFPA 501A, Manufactured Home Installations Standard* when none of the previously referenced standard are applicable.
- D. Eliminate drafts **before** using the gas appliance by closing heating and air conditioning vents, returns, and outside air vents. Fans blowing directly into the fireplace must be turned off when this appliance is operating.
- E. **WARNING:** This appliance is for installation only in a solid-fuel-burning masonry or UL 127 factory-built fireplace or in a listed ventless firebox enclosure. It has been design certified for these installations. Exception: **DO NOT** install this appliance in a factory-built fireplace that includes instructions stating it has not been tested or should not be used with unvented gas burner systems.
- F. **WARNING: DO NOT MODIFY THIS VENT-FREE HEATER OR ITS CONTROLS. Any change may be dangerous.** Improper installation or use of your vent-free gas appliance can cause serious injury or death from fire, burns, explosions, or carbon monoxide poisoning.
- G. State and local codes may only allow operation of this appliance in a vented configuration. Check your state or local codes.
- H. **WHEN INSTALLING AS A DECORATIVE VENTED APPLIANCE, THE UNIT MUST CONFORM TO ALL LOCAL CODES AND TO THE LATEST EDITION OF THE NATIONAL FUEL GAS CODE ANSI Z223.1/NFPA54.**

VENTILATION AND CONFINED SPACE SAFETY INFORMATION

Your vent-free gas burner system **SHALL NOT BE INSTALLED IN A CONFINED SPACE** or unusually tight construction unless provisions are made for adequate combustion and ventilation air.

- The National Fuel Gas Code, ANSI Z223.1/NFPA 54 defines a confined space as a space whose volume is less than 50 cu. ft. per 1,000 BTU per hour (4.8 meters³ per kw) of the aggregate input rating of all appliances installed in that space.
- An unconfined space is a space where volume is at least 50 cu. ft. per 1,000 BTU per hour (4.8 meters³ per kw) of the aggregate input rating of all appliances installed in that space.
- Rooms communicating directly with the space in which the appliances are installed, through openings not furnished with doors, are considered a part of the unconfined space.

WARNING: Do not install the unvented burner system where the room is considered a confined space (see Fig. 5-1).

To determine if the area where this burner system is to be installed fits the definition of an unconfined space, multiply the length of the room by the width of the room by the height of the room, then multiply by 20. The result is the maximum BTU allowed.

(Length x Width x Height x 20 = Maximum BTUs allowed)

Example: To install a Peterson Real-Fyre[®] vent-free gas burner system with 36,000 BTU, maximum, in a space with no other gas-burning appliances, the space **MUST** be 1,800 cu. ft. or larger.

Assuming an 8' ceiling, floor dimensions must be a minimum of 225 sq. ft., i.e.; 18'x12.5'=225 sq ft (see Fig. 5-1).

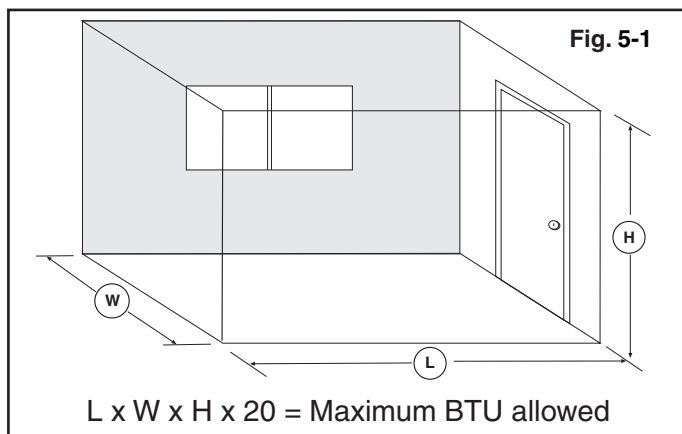

WARNING

If the area in which the heater may be operated is smaller than that defined as an unconfined space or if the building is of unusually tight construction, provide adequate combustion and ventilation air by one of the methods described in the National Fuel Gas Code, ANSI Z223.1/NFPA 54, Air for Combustion and Ventilation, or applicable local codes.

REMEMBER

L x W x H x 20 = MAXIMUM BTUs ALLOWED

If the space is smaller than the above formula allows, and/or smaller than the examples and diagrams on this page specify, **DO NOT** install the vent-free burner system unless provisions for additional combustion and ventilation air are made.

IT MAY BE NECESSARY TO OPEN A WINDOW SLIGHTLY (1"- 2") OR OTHERWISE INCREASE VENTILATION. CONDITIONS REQUIRING THIS INCLUDE, BUT ARE NOT LIMITED TO:

1. Installation in a **CONFINED SPACE**.
2. Installation in a **HOME OF UNUSUALLY TIGHT CONSTRUCTION****.
3. Installation at **HIGH ALTITUDES**.
4. **Certain MEDICAL OR PHYSICAL CONDITIONS OF THE HOMEOWNER** that may be adversely impacted by combustion products created by burning natural or propane gas.

Installation in a tightly constructed home and/or installation at high altitudes may cause your vent-free burner system to produce excessive heat or excessive moisture. The oxygen depletion sensor may shut down the burner system. These conditions may be corrected by opening a window or otherwise increasing the number of air changes in the home.

****Unusually tight construction** is defined as construction where:

- a. Walls and ceilings exposed to the outside atmosphere have a continuous water vapor retarder with a rating of 1 perm (6x10⁻¹¹ kg per pa-sec-m²), or less with openings gasketed or sealed;
- b. Weather stripping has been added on openable windows and doors, and
- c. Caulking or sealants are applied to areas such as joints around window and door frames, between sole plates and floors, between wall-ceiling joints, between wall panels, at penetrations for plumbing, electrical, and gas lines, and at other openings.

The Peterson Real-Fyre[®] vent-free burner system has been certified to function safely and reliably with emission by-products well within accepted safety and health standards. **Your specific medical or physical condition** may render you more sensitive to products created by burning natural or propane gas. If this is the case, you should open a window or otherwise increase ventilation.

MINIMUM CLEARANCES TO COMBUSTIBLES

If the vent-free gas log set is installed in a factory built fireplace, follow the manufacturer's guidelines for minimum clearances to combustibles.

In the absence of such guidelines, follow the instructions below:

Clearances to Combustible Construction:

Sidewalls: 16" from side of fireplace opening (Fig. 6-1).

Ceiling: 42" from top of fireplace opening (Fig. 6-1).

Flooring: See IN FRONT OF FIREPLACE section below.

Mantel: See ABOVE THE FIREPLACE section below & Fig. 6-1. Also see Fig. x-1, & x-2 on following page).

Note: Clearances to combustible construction are those distances required to ensure that fireplace mantels, facings, walls, ceilings, and floorings will not catch fire.

In most cases, these clearances should also be adequate to prevent any discoloration or warping due to heat. However, every gas log installation presents a different and unique set of circumstances involving many variables beyond the control of the gas log manufacturer. These include paint or finish composition, previous exposure to heat, methods and quality of construction, air flow patterns, glass doors, fans or blowers, etc.

IN FRONT OF THE FIREPLACE:

Be certain that combustible flooring material (i.e.: carpet, tile, etc.) is not too close to the vent-free gas log set. If the vent-free gas log set is at floor level or less than 6" above the floor, there **MUST** be at least 12" (1 foot) of noncombustible material between the front of the fireplace and any combustible flooring.

ABOVE THE FIREPLACE:

To install the vent-free gas log set, there must **ALWAYS** be noncombustible or heat resistant material immediately above the fireplace opening. Heat resistant materials (i.e., marble or slate) must be at least $\frac{5}{8}$ " thick. Sheet metal should not be installed onto combustible materials.

If you **DO NOT** install a fireplace hood, there **MUST** be at least 12" of noncombustible or heat resistant material immediately above the fireplace opening (**see A** in Fig. x-1 on the following page). If you **DO** install a fireplace hood, there **MUST** be at least 10" of noncombustible or heat resistant material immediately above the fireplace opening (**see B** in Fig. x-2 on the following page). If there is a wooden mantel, shelf, or other combustible projection above the fireplace, follow the information in the Figures on the next page.

EXAMPLE: If the fireplace has a combustible projection (mantel or shelf) 20" above the top of the firebox, the maximum horizontal projection out from the face of the fireplace will be:

1. If a fireplace hood is not installed - **2.5"** (see Fig. x-1 on the following page).
2. If a fireplace hood is installed ----- **10"** (see Fig. x-2 on the following page).

A fireplace hood deflects heat away from the fireplace face and mantel, reducing the potential for heat related warping or discoloration. The use of a fireplace hood is highly recommended.

IF YOU CANNOT MEET THESE MINIMUM CLEARANCES, YOU MUST OPERATE THE VENT-FREE GAS LOG SET WITH THE CHIMNEY FLUE DAMPER OPEN.

Because of these variables, we cannot guarantee that heat warping or discoloration will never occur. The potential for heat warping or discoloration may exist no matter what item(s) you are burning in the fireplace, including wood.

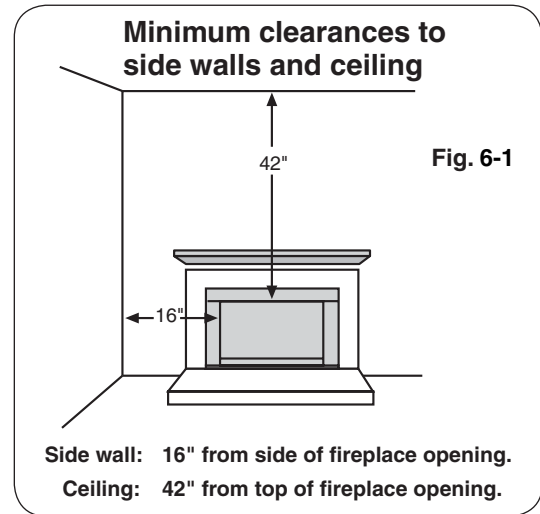

The dimensions in Fig. 6-1 are **MINIMUM CLEARANCES** to maintain when you install this gas log set. **BOTH SIDES** of the fireplace opening **MUST BE AT LEAST 16"** from any combustible sidewalls. The ceiling **MUST BE** at least **42"** from the top of the fireplace opening.

MINIMUM CLEARANCES TO COMBUSTIBLES (Cont.)

IF YOU CANNOT MEET THESE MINIMUM CLEARANCES, YOU MUST OPERATE THE VENT-FREE GAS LOG SET WITH THE CHIMNEY FLUE DAMPER OPEN.

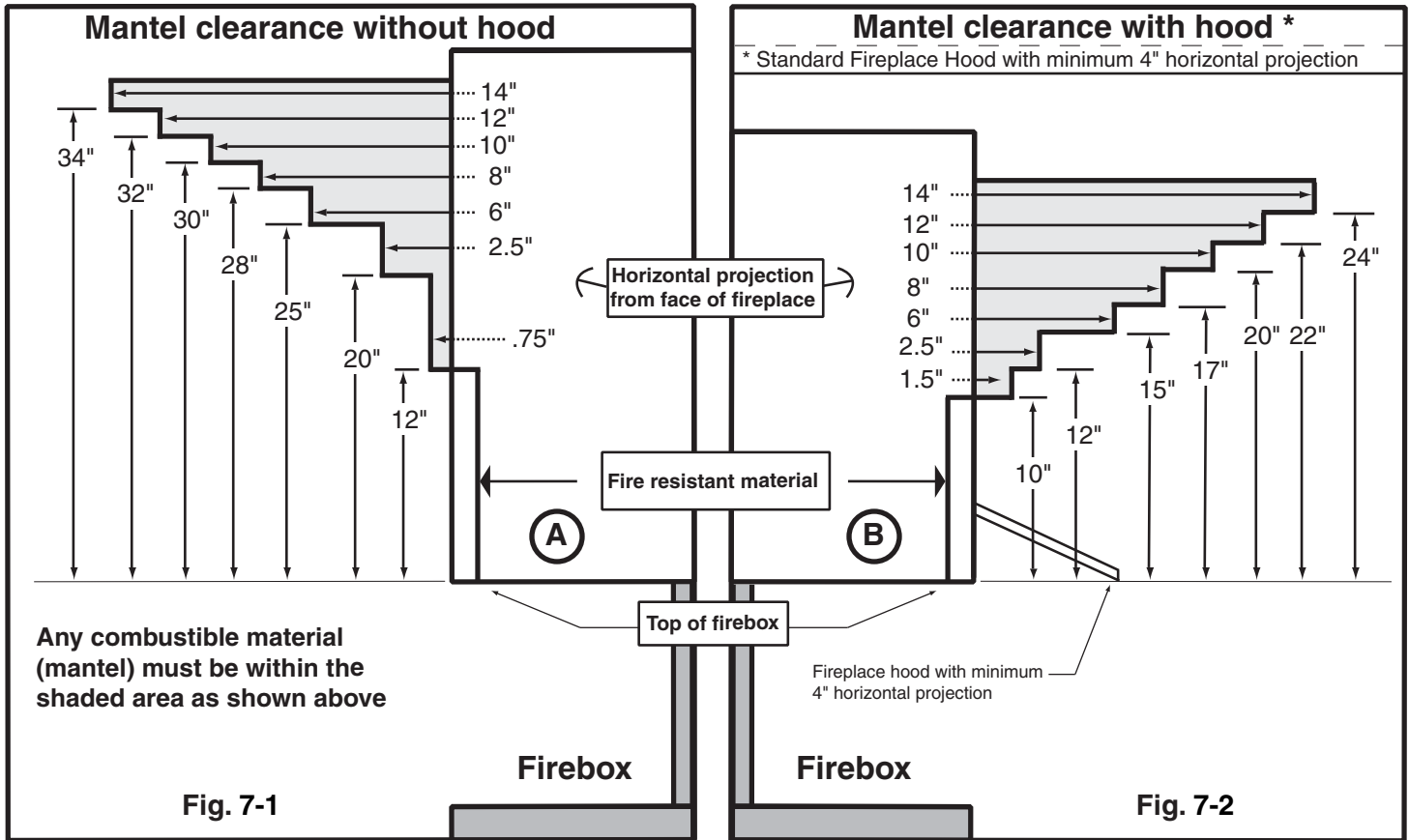

PRE-INSTALLATION AND FIREPLACE PREPARATION SAFETY

CAUTION: Installation and repair must be done by a qualified professional installer.

Installer: Carefully read these instructions before installing this gas burner system. Be sure you understand all safety precautions and warnings contained in this manual.

PRE-INSTALLATION AND FIREPLACE PREPARATION SAFETY GUIDELINES

- A. This appliance is only for use with the type of gas indicated on the rating plate. This appliance is **NOT CONVERTIBLE** for use with other gasses.
- B. **CAUTION: If not installed, serviced, and used correctly per these instructions, this product can cause serious personal injury, property damage, or loss of life.**
- C. **WARNING:** Before installing in a solid-fuel-burning fireplace, the chimney flue, damper, and firebox must be thoroughly CLEANED of soot, creosote, ashes, and loose paint by a qualified chimney cleaner. Some fireplaces (especially older ones) may need repair prior to installing this appliance.
- D. CHECK GAS TYPE (natural or propane): The gas supply must be the same as stated on your burner system rating plate. If gas supply is different, **DO NOT INSTALL**. Contact your dealer for immediate assistance.
- E. Any outside air ducts and/or ash dumps located on the floor or walls of the fireplace must be permanently sealed shut before the installation. Use a heat-resistant sealant. Do not seal the chimney flue damper.
- F. INSUFFICIENT GAS PRESSURE WILL KEEP THE ODS (OXYGEN DEPLETION SENSOR) PILOT FROM OPERATING PROPERLY. DO NOT USE IF GAS PRESSURE IS LOWER THAN THE MINIMUM REQUIREMENT.
- G. The *minimum* inlet gas-supply pressure for purposes of input adjustment is **5"** water column (w.c.) on **natural gas** and **11"** w.c. on **propane gas**. Insufficient gas pressure will affect proper operation of the ODS pilot. Do not install this gas appliance if minimum pressure is not available. The *maximum* inlet gas-supply pressure is **10.5"** w.c. on natural gas and **13"** w.c. on propane gas. The propane source must be regulated. (Do not connect this appliance directly to an unregulated propane gas tank - this can cause an explosion.)
- H. The gas piping system must be sized to provide minimum inlet pressure at the maximum flow rate (BTU/hr). Undue pressure loss will occur if the pipe is too small, or the run is too long.
- I. The minimum clearance from the fireplace opening to combustible materials on side walls and ceiling must be maintained as outlined in MINIMUM CLEARANCE TO COMBUSTIBLES - WALLS AND CEILING.
- J. At least 10"-12" of noncombustible or heat-resistant material is required above the fireplace. A fireplace hood will be required to act as a heat deflector in protecting combustible fireplace surrounds (facing and/or mantel) if certain minimum clearances cannot be met.
- K. Be certain that combustible flooring material (i.e., carpet, tile, etc.) is not too close to this gas appliance. If this appliance is at floor level or less than 6" above the floor, there must be at least 12" of noncombustible material between the base of the fireplace and any combustible flooring.
- L. Input ratings shown in BTU per hour are for elevations up to 2,000 ft. For elevations above 2,000 ft., refer to the National Fuel Gas Code or contact the Robert H. Peterson Company before installing this product.
- M. This gas appliance and its main gas valve must be disconnected from the gas-supply piping system during any pressure testing of that system at test pressures in excess of 1/2 psig.
- N. This gas appliance must be isolated from the gas-supply piping system by closing the equipment shutoff valve connected to the gas-supply line during any pressure testing of the gas-supply piping system at test pressures equal to or less than 1/2 psig.
- O. Do not use this appliance if any part has been underwater. Immediately call a qualified professional service technician to inspect the appliance and to replace any part of the control system and any gas control that has been underwater.

WARNING

THIS APPLIANCE IS EQUIPPED FOR EITHER NATURAL OR PROPANE GAS.
FIELD CONVERSION IS NOT PERMITTED.

INSTALLATION SAFETY INFORMATION

INSTALLATION SAFETY GUIDELINES

- A. Carefully inspect the burner and cartons for shipping damage. If any parts are missing/damaged, call your dealer. **Do not attempt** to install the appliance unless all parts are in good condition.
- B. Correct installation of the glass or the ceramic refractory log set and proper placement and installation of the burner assembly, including ember placement and Lava Granule placement, are imperative to safe operation of your set. Problems **WILL** occur if all items are not properly installed. Reference the INSTALLATION section, LOG PLACEMENT.
- C. When installing in a wood-burning fireplace, **center the appliance in the fireplace** while making certain that no part of the assembly protrudes (forward) beyond the face of the fireplace.
DO NOT PUSH THE UNIT ALL THE WAY TO THE BACK.
- D. If you use Lava Granules, or glass or gems, for decorative use, do not allow these accessories into or onto any part of the burner or on the logs. Lava Granules, or glass or gems used to accessorize the vent-free burner, should only be placed on the floor of the fireplace, in front of and to the sides of the burner, but away from the controls.
- E. DO NOT PLACE logs or other accessories, such as wood chips, pine cones, or vermiculite, on this appliance. These items will cause improper burning, sooting, and/or high levels of carbon monoxide. Additional logs and/or accessories may be placed around the burner system, as long as they do not interfere with the burning of your gas appliance.
- F. **Due to high temperatures, this appliance should be located out of traffic and away from furniture/draperies.**
- G. A fireplace screen must be in place when this gas appliance is in operation. Unless other provisions for combustion air are provided, the screen shall have an opening(s) for introduction of combustion air.
- H. Connecting directly to an unregulated propane tank can cause an explosion.
 - I. Special care is required if you are installing the unit into a **SUNKEN FIREPLACE**. You must raise the fireplace floor to allow access to gas controls. This will ensure adequate airflow and guard against sooting. Raise the fireplace floor using noncombustible materials.
- J. A vent-free room heater having an input rating of more than 10,000 BTU per hour shall not be installed in a bedroom (ANSI Z21.11.2).
If local codes allow, you may install a G8-xxR burner, having a rating of 9,500 BTU, in a bedroom. An unvented room heater having an input rating of more than 6,000 BTU per hour shall not be installed in a bathroom (ANSI Z21.11.2).

OPERATIONAL SAFETY INFORMATION

OPERATING YOUR UNVENTED GAS APPLIANCE SAFELY AND CORRECTLY

- A. SOLID FUEL MUST NOT BE BURNED** in a fireplace where this vent-free gas appliance is installed.
- B. GLASS DOORS MUST BE FULLY OPEN** when this vent-free gas appliance is operating. This appliance **MUST NOT BE ON** if glass doors are closed, as it can lead to sooting, burner outages, and possibly explosion, causing damage or injury.
- C. WARNING: DO NOT ALLOW DRAFTS INTO OR AROUND THE FIREPLACE. CLOSE (SHUT) HEATING AND AIR CONDITIONING VENTS, RETURNS, AND OUTSIDE AIR VENTS. DO NOT OPERATE FANS (WINDOW FANS, CEILING FANS, FLOOR FANS), WHICH MAY ALTER FLAME PATTERNS.** Sooting, excess carbon monoxide, or ODS pilot outages may occur due to drafts.
- D. WARNING: DO NOT USE A BLOWER INSERT, HEAT EXCHANGER INSERT,** or any other accessory that is not specifically certified for use with this vent-free gas appliance.
- E.** Make sure there is adequate combustion and ventilation air when this gas appliance is operating. You may need to crack the damper or open a window slightly.
- F. THIS APPLIANCE MUST BE MAINTAINED IN A WELL-CLEANED CONDITION AT ALL TIMES. REGULAR (AT LEAST ONCE PER YEAR) CLEANING OF THE BURNER AND ODS PILOT IS REQUIRED BY A QUALIFIED PROFESSIONAL SERVICE TECHNICIAN.**
- G.** To light this appliance, it may be necessary to purge the unit for longer than one minute after long periods of non-use.
- H.** If you operate this vent-free gas appliance fueled by propane, operating characteristics may vary as the fuel in the tank approaches empty (less than $\frac{1}{4}$ full). Sooting and other increases in combustion by-products will occur. Turn off the appliance, refill the propane tank, and have the burners cleaned.
- I.** During manufacturing, various parts of this unit are treated with oils or paints. Though not harmful, they may produce annoying smoke and smells as they are burned off during initial operation. This is a normal occurrence. Initial break-in period should last four to six hours; maximum ventilation should be provided by opening windows, doors, or chimney flue.
- J.** Keep the area around your gas appliance clear of combustible materials, gasoline, and any other flammable vapors/liquids. Provide adequate clearance for servicing and operation. Be especially cautious if this gas appliance is installed in a basement or converted garage.
- K. Do not place clothing or any flammable material on or near your vent-free gas appliance. Matches, paper, garbage, or any other material must not be thrown on top of the logs, burner, or into the flame.**
- L. Young children should be carefully supervised when in the same room with this appliance.**
- M. Children and adults should be alerted to the hazard of high surface temperatures and should stay away to avoid burns or clothing ignition.**

OPERATING YOUR UNVENTED GAS APPLIANCE SAFELY AND CORRECTLY

N. This appliance is intended for supplemental heating, and is not to be used as a primary heating source. Water vapor produced by vent-free burner systems can create moisture problems in a home when operated for extended periods of time. If condensation begins to occur, open your damper or a window.

As a supplemental zone heater, this set should not be used more than six continuous hours per day or more than 40 hours per week. More frequent use indicates that this unit is being used as a primary heat source. The higher presence of carbon monoxide generated by this amount of use can be considered unsafe.

O. If the gas quality is poor or pressure low, your ODS pilot may not stay lit, the burners may produce soot, or the unit may backfire. Contact your local gas supplier immediately.

P. This appliance is designed for adults to be present while in operation. Do not leave this unit burning when unattended or while sleeping. **This is an attended appliance.**

Q. WARNING: Failure to keep the primary air opening(s) of the burner(s) clean may result in sooting and property damage.

R. WARNING: All previously applied loose material, such as embers, must be removed prior to reapplication. All replacement loose material must be purchased from the original appliance manufacturer.

S. Unusually tight construction is defined as:

a) Walls and ceilings exposed to the outside atmosphere have a continuous water vapor retarder with a rating of 1 perm (6×10^{-11} kg per pa-sec- m^2) or less with openings that are sealed or use gaskets;

b) Weather stripping has been added on openable windows and doors; **AND**

c) Caulking or sealants are applied to areas such as joints around window and door frames; between sole plates and floors; between wall-ceiling joints; between wall panels; at penetrations for plumbing, electrical, and gas lines; and at other openings.

CLEANING AND SERVICING IMPORTANT INFORMATION

It is imperative that you maintain your unvented gas appliance by having it cleaned and serviced regularly. A qualified professional service technician shall inspect and service this unit at least annually. (Read and follow the CLEANING AND SERVICING sections for details.)

Failure to provide reasonable and necessary maintenance as outlined in the owner's manual will cause your appliance to malfunction and will void your warranty.

LOGS - PARTS LIST

Log sets are purchased and packaged separately. Styles and sizes will vary depending upon the log set ordered.

WARNING: Failure to position these parts in accordance with these diagrams, or failure to use only parts specifically approved with this vent-free gas log set, may result in property damage or personal injury.

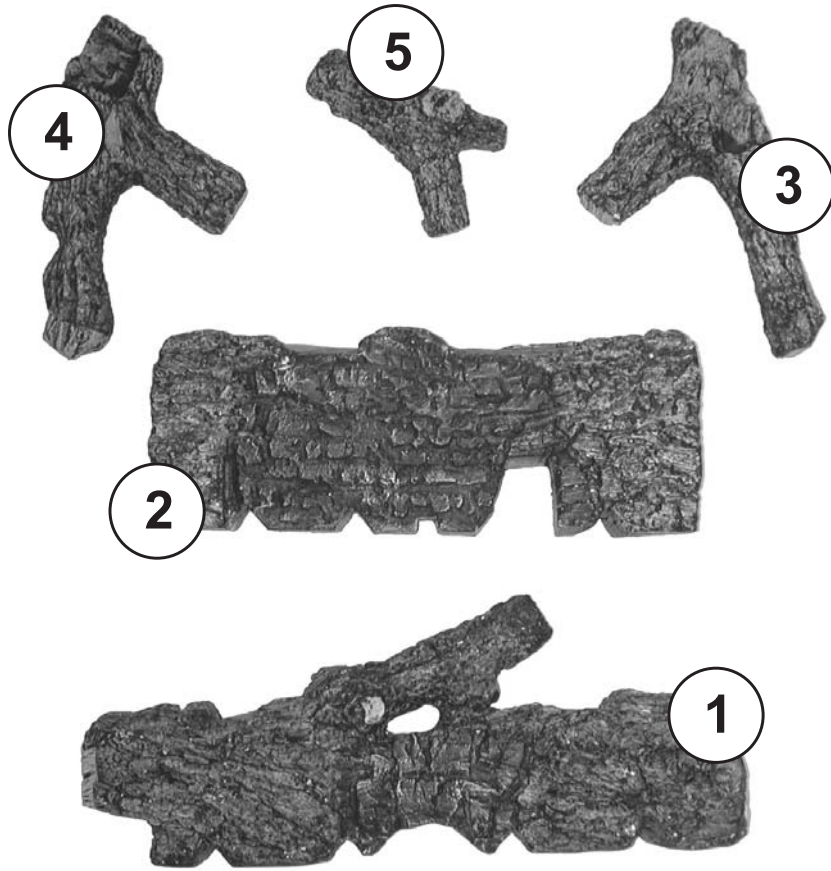

CHFR-16/18 Charred Frontier Oak Log Set

| ITEM NO. | PART NO. | DESCRIPTION |
|----------|--------------|--------------------------|
| 1. | CHFR-16/18BF | Charred bottom front log |
| 2. | CHFR-15BR | Charred rear log |
| 3. | CHFR-11TL | Top left log |
| 4. | CHFR-9TR | Top right log |
| 5. | CHFR-6TC | Charred top log |

(Also available in Charred Aged Split finish-CHAS)

Also included with limited gas log sets

Decorative wood chip
[provided with 15(M)(P) and
01V(P) gas log sets]



Note: For both set styles, each log is numbered to aid exact placement, giving the correct spacing for proper performance of the gas log set (see installation section for placement details).

BURNER PARTS LIST FOR 15 SERIES VALVE

G10-16/18-15(M)(P)

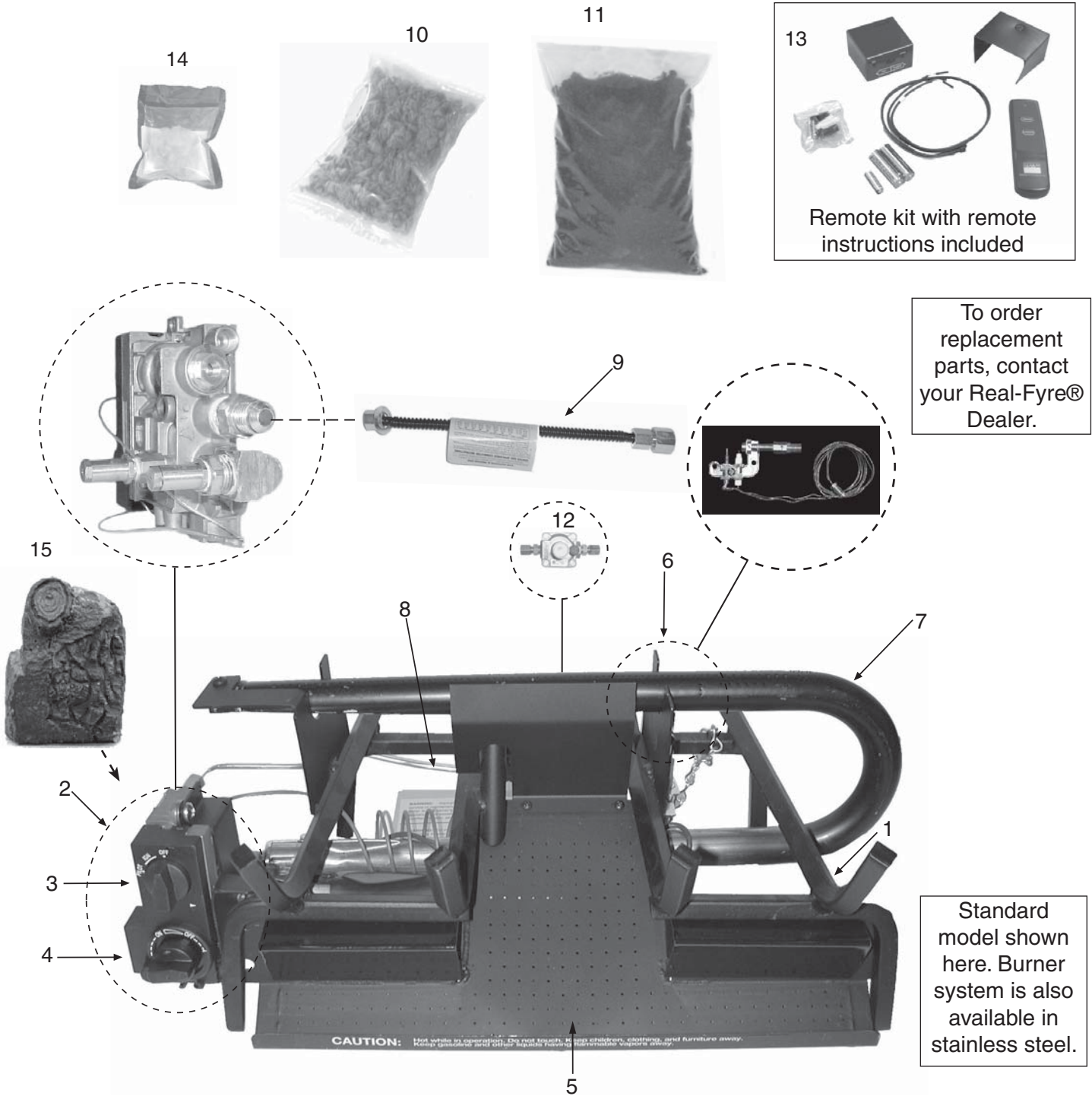

| ITEM NO. | ITEM DESCRIPTION |
|----------|--------------------------------|
| 1. | Grate assembly |
| 2. | Valve assembly (natural) |
| or | Valve assembly (propane) |
| 3. | Ignitor control knob |
| 4. | Flame height control knob |
| 5. | Ember burner |
| 6. | ODS pilot (natural or propane) |
| 7. | Main burner |

| ITEM NO. | ITEM DESCRIPTION |
|----------|--------------------------------------|
| 8. | ODS pilot gas supply tube |
| 9. | Connector kit, 30" |
| 10. | Embers |
| 11. | Lava granules |
| 12. | Pressure regulator, for natural only |
| 13. | Remote kit (optional) |
| 14. | Bryte coals |
| 15. | Decorative wood chip |

BURNER PARTS LIST FOR MANUAL VALVE

G10-16/18(P)

To order replacement parts, contact your Real-Fyre® Dealer.

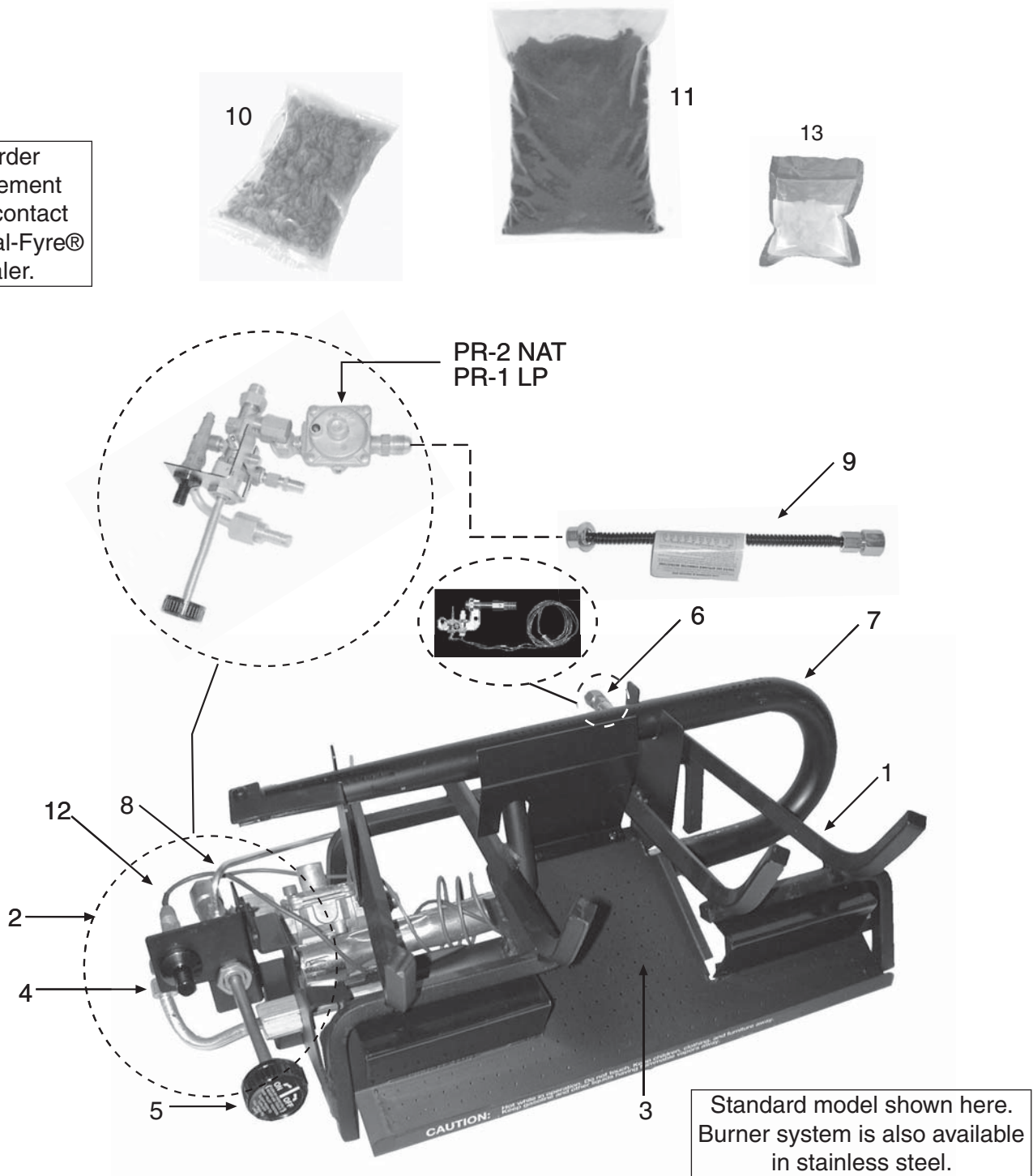

ITEM NO. ITEM DESCRIPTION

- 1. Grate assembly
- 2. Valve assembly (natural)
or Valve assembly (propane)
- 3. Ember burner
- 4. Piezo ignitor
- 5. Flame height control knob
- 6. ODS pilot (natural)
or ODS pilot (propane)

ITEM NO. ITEM DESCRIPTION

- 7. Main burner
- 8. ODS pilot gas supply tube
- 9. Connector kit, 30"
- 10. Embers
- 11. Lava granules
- 12. Piezo ignitor wire
- 13. Bryte coals

BURNER PARTS LIST FOR 12 SERIES VALVE

G10-16/18-12(M)(P)

To order replacement parts, contact your Real-Fyre® Dealer.

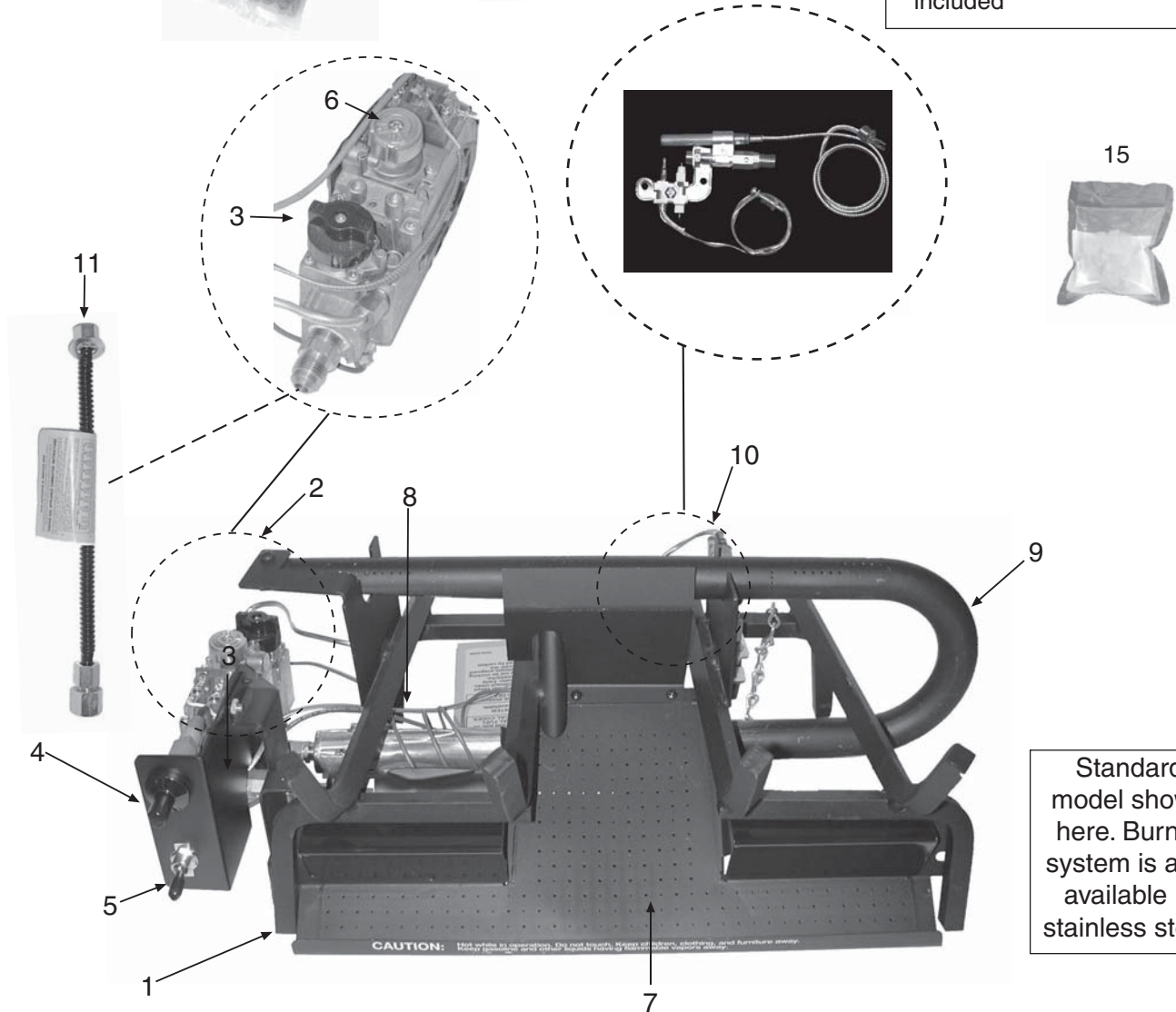
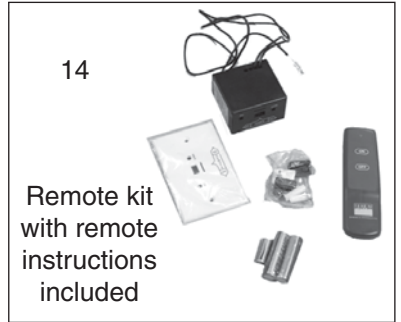
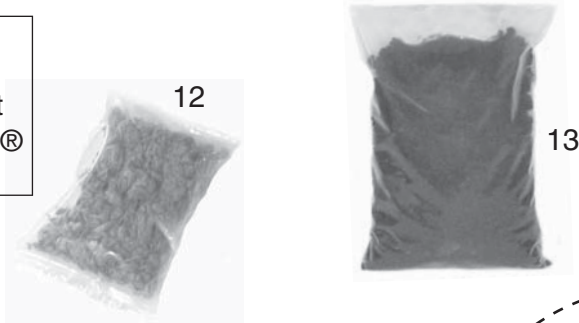

Standard model shown here. Burner system is also available in stainless steel.

| ITEM NO. | ITEM DESCRIPTION |
|----------|---------------------------|
| 1. | Grate assembly |
| 2. | Valve assembly (natural) |
| or | Valve assembly (propane) |
| 3. | ON/OFF/PILOT knob |
| 4. | Piezo ignitor |
| 5. | Main burner ON/OFF switch |
| 6. | Flame height control knob |
| 7. | Ember burner |
| 8. | ODS pilot gas supply tube |

| ITEM NO. | ITEM DESCRIPTION |
|----------|-----------------------|
| 9. | Main burner |
| 10. | ODS pilot (natural) |
| or | ODS pilot (propane) |
| 11. | Connector kit, 30" |
| 12. | Embers |
| 13. | Lava granules |
| 14. | Remote kit (optional) |
| 15. | Bryte coals |

BURNER PARTS LIST FOR 01V SERIES VALVE

G10-16/18-01V(P)

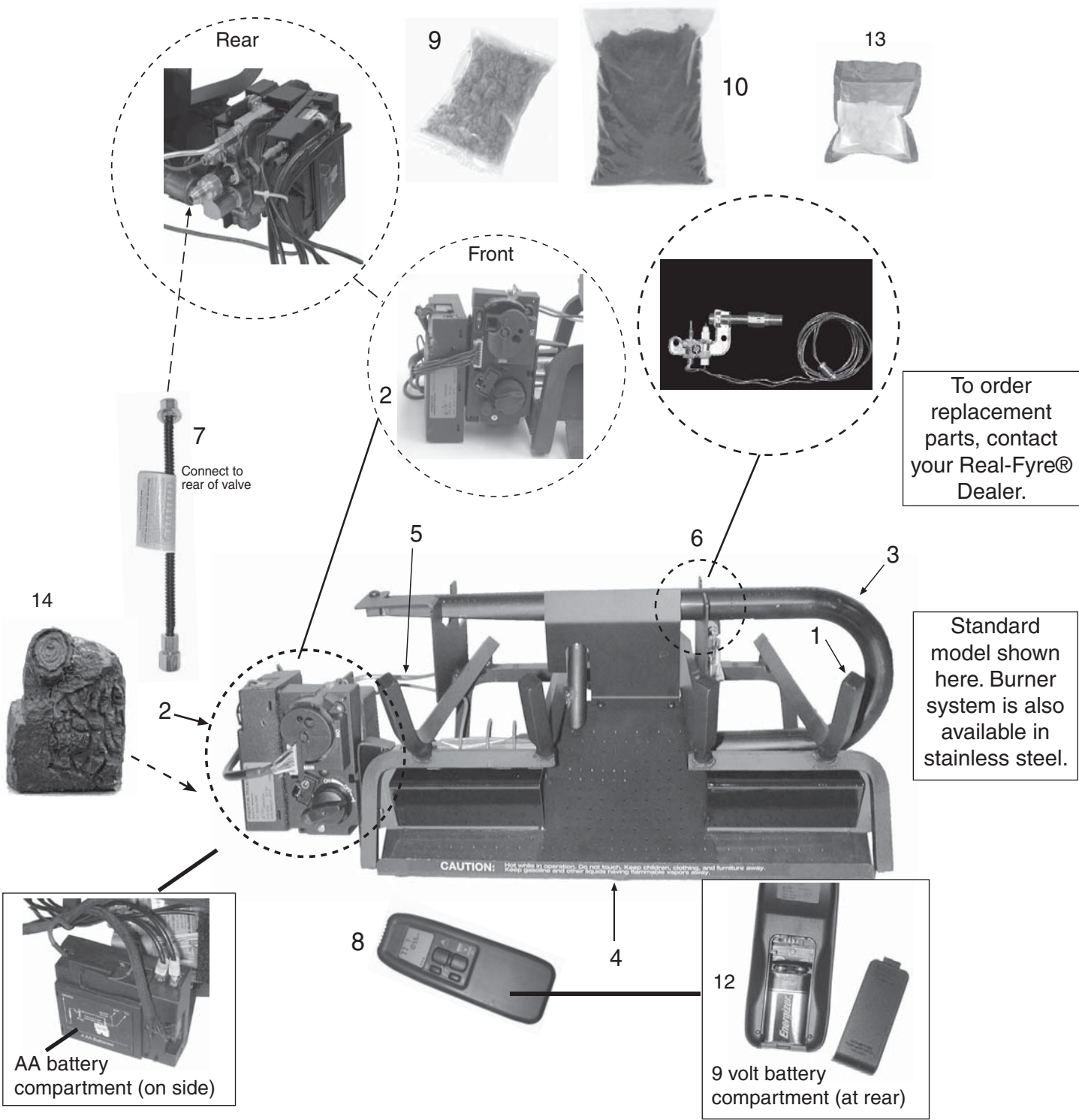

ITEM NO. ITEM DESCRIPTION

- 1. Grate assembly
- 2. 01 electronic valve assembly with receiver for natural or propane gas
- 3. G10 main burner
- 4. Ember burner
- 5. ODS pilot gas supply tube
- 6. ODS pilot (natural)
or ODS pilot (propane)

ITEM NO. ITEM DESCRIPTION

- 7. Connector kit, 30"
- 8. Remote handset (supplied)
- 9. Embers
- 10. Lava granules
- 11. AA batteries (4) -not shown
- 12. 9 volt battery (1) see inset above
- 13. Bryte coals
- 14. Decorative wood chip

WHEN USED AS A VENTED DECORATIVE APPLIANCE (PER ANSI Z21.60b-2004)

This appliance is for installation in a solid fuel burning fireplace (masonry fireplace or manufactured fireplace) with a working flue and constructed of noncombustible material.

These gas logs may be installed as vented decorative log sets in compliance with ANSI Z21.60b-2004 and National Fuel Gas Code, Section 6.6. The minimum permanent free opening of the fireplace chimney or chimney damper must be met per the Chimney Vent Opening Table on pg 3 of this manual. Chimney damper must be fixed in a manner to maintain permanent free opening at all times. To accomplish this, install a screw or bolt in the edge of the damper to prevent closing, or drill holes in the damper or remove the damper.

INSTALLATION - CONNECTING THE GAS TO THE BURNER SYSTEM

BEFORE PROCEEDING, CAREFULLY READ ALL OF THE IMPORTANT SAFETY INFORMATION CONTAINED IN THIS OWNER'S MANUAL, INCLUDING:

- A. Pre-Installation and Fireplace Preparation Safety Guidelines
- B. Ventilation and Confined Space Information
- C. Installation Safety Guidelines

I M P O R T A N T

Be sure you have read and understand all safety precautions and warnings contained in this manual.

Note: To install the Real-Fyre® vent-free gas log set, the fireplace must have a gas supply line that has been installed by a qualified professional technician in accordance with all local codes. Refer to the PARTS LIST when installing the vent-free gas log set.

Tools Required:

- | | |
|---|--|
| 1. Adjustable open-ended wrench | 4. Soapy water solution & brush for leak detection |
| 2. Pliers | 5. Flat-head screwdriver |
| 3. Propane gas resistant pipe compound or Teflon tape | 6. Manometer (recommended for checking gas pressure) |

CHECK GAS TYPE (natural or propane). The gas supply must be the same as stated on the gas log set rating plate. **If the gas supply is different, DO NOT INSTALL.** Contact the dealer for immediate assistance.

W A R N I N G

Do not connect this appliance directly to a high pressure natural gas line or an unregulated propane tank.

Refer to the PARTS LIST when installing the vent-free gas log set.

1. **MAKE SURE THE FIREPLACE GAS SUPPLY IS TURNED OFF.**
2. Center the burner assembly in the fireplace. Make certain that no part of the assembly protrudes beyond the face of the fireplace.
3. Attach the large adaptor fitting of the flex connector kit to the fireplace gas supply line using pipe compound resistant to propane gas or Teflon tape. Tighten the connection. Connect one end of flex connector to the large adaptor, and the other end to the adaptor on the valve assembly.
4. Make sure that the control valve on the burner system is in the **OFF** position. Turn on the gas to the fireplace and check for leaks at all connections.

LEAK TESTING

Make sure that the control valve on the burner system is in the **OFF** position. Carefully turn on the gas to the fireplace and leak test at all connections with a soapy water solution (equal parts liquid detergent and water). If bubbles appear, a leak is present. Turn off the gas and tighten all connections, then turn on the gas and repeat the leak test. Repeat until no leaks are detected.

NEVER USE A FLAME TO CHECK FOR GAS LEAKS.

INSTALLATION

IMPORTANT

For all valves, the air **MUST** be purged from the gas line before the ODS pilot will light properly. The time taken to do this will depend on the length of gas line from the meter to the unit and the length of time since the unit or gas line was last used (in the case of non-use during warm weather for example). It may take from 3-15 minutes before all the air is purged and the ODS pilot will light properly. This is done using different methods, depending on which valve is fitted to the unit. Follow the relevant LIGHTING INSTRUCTIONS in this manual for the specific valve type.

- A. G10-16/18(P) - Hold in control knob at PILOT (see Fig. 18-2).
- B. G10-16/18-12(M)(P) - Hold down control knob at PILOT (see Fig. 18-3).
- C. G10-16/18-15(M)(P) - Hold in control knob at PILOT (see Fig. 18-4).
- D. G10-16/18-01V(P) - Set control to manual. Press O/I to I (see Fig. 18-5).
Use a pen tip to activate the switch inside the hole as shown in Fig. 18-1.

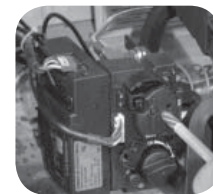

Fig. 18-1

CONTROL SETTINGS

We recommend that before you install the log set you familiarize yourself with the control valve layout. This will help you to be confident operating the log set when fully installed. See the figures below for typical control positions.

MANUAL GAS VALVE OPERATING POSITIONS

OFF PILOT ON/ HIGH ON/ LOW



Fig. 18-2

12 SERIES REMOTE GAS VALVE OPERATING POSITIONS

OFF PILOT ON

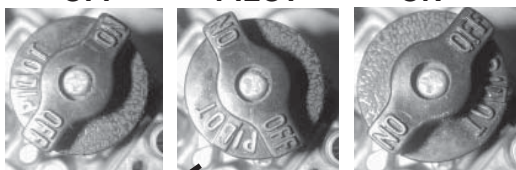

Read setting here

Fig. 18-3

15 SERIES REMOTE GAS VALVE OPERATING POSITIONS

OFF IGNITION PILOT ON

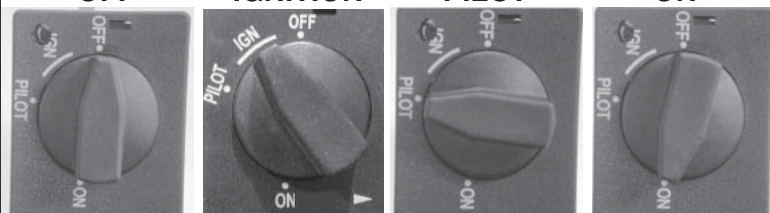
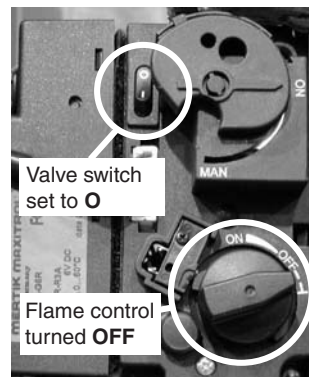

Fig. 18-4

01V SERIES REMOTE GAS VALVE OPERATING POSITIONS

OFF



PILOT ON

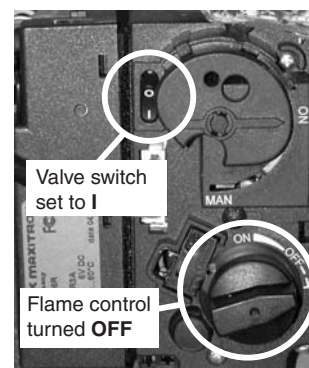

ON

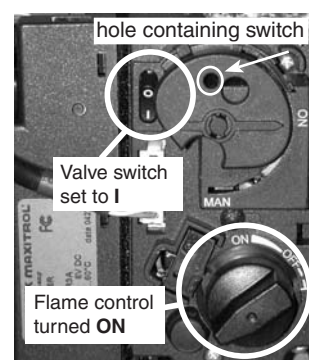

Fig. 18-5

INSTALLATION - CHECKING GAS PRESSURE

I M P O R T A N T

Check the gas pressure with the vent-free gas log set burning and the control set to **HIGH**.

The gas log set and its main gas valve must be disconnected from the gas supply piping system during any pressure testing of that system at test pressures in excess of 1/2 psig. (3.5 kPa) The gas log set must be isolated from the gas supply piping system by closing its equipment shut-off valve during any pressure testing of the gas supply piping system at test pressures equal to or less than 1/2 psig. (3.5 kPa) This is accomplished by closing the gas supply line valve.

CHECKING GAS PRESSURE

Remote-capable safety pilot valve (Fig. 19-1)

Check the valve regulator pressure at the pressure *inlet* point. Turn the inlet screw counterclockwise 2 or 3 turns and then place the tubing of the pressure gauge over the pressure *inlet* point. (The test inlet point is farthest to the gas supply inlet). After taking the pressure reading, turn the inlet screw clockwise firmly to reseal. Do not over torque. Check for gas leaks.

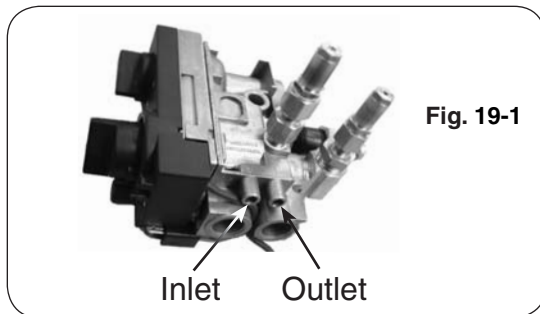

Manual safety pilot valve (Fig. 19-2) The pressure regulator is preset at the factory and locked to discourage tampering. If the pressure is not as specified, replace the regulator with the correct part from the PARTS LIST in this manual. To check the pressure, remove 1/8" pressure tap screw plug, located on the side of the regulator body. Install fitting and tubing of pressure gauge. With the unit operating take the pressure reading. Reinstall the pressure tap screw and check for leaks when done.

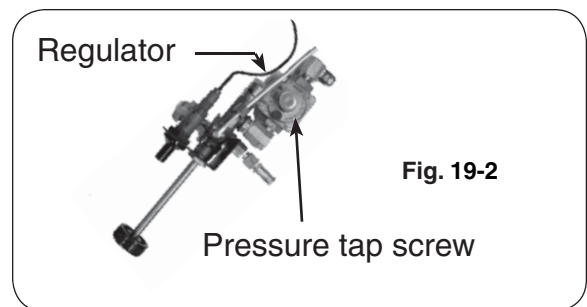

The vent-free burner system will need to be propped up to allow access to the pressure *inlet* and *outlet* points on the bottom side of the valve.

Note: Gas pressure should be checked after connecting the gas and prior to any further installation.

GAS PRESSURE SPECIFICATIONS

| NATURAL GAS | | | |
|-----------------------------|---------------------------------|--|---------------------------------|
| MANUAL PRESSURE | | MILLIVOLT PRESSURE | |
| Regulator pressure reading: | 3.5" w.c. | Outlet pressure reading: (Flame adjustment on high) | 3.5" w.c. |
| Gas inlet pressure: | Max. 10.5" w.c. Min. 5" w.c. | Inlet pressure reading | Max. 10.5" w.c. Min. 5" w.c. |
| PROPANE (L.P.) GAS | | | |
| MANUAL PRESSURE | | MILLIVOLT PRESSURE | |
| Regulator pressure reading: | 10" w.c. | Outlet pressure reading: (Flame adjustment on high) | 10" w.c. |
| Gas inlet pressure: | Max. 13" w.c. Min. 11" w.c. | Inlet pressure reading | Max. 13" w.c. Min. 11" w.c. |

INSTALLATION - GRANULE, EMBER AND LOG PLACEMENT

LAVA GRANULE PLACEMENT

Lava granules are provided as an aesthetic enhancement to the G10 vent-free gas log set.

Spread the lava granules on the floor of the firebox around the front and the sides of the vent-free gas log set (Fig. 20-1).

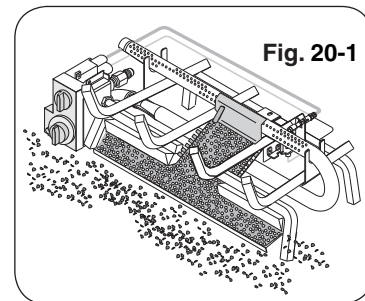

BE SURE THAT NO GRANULES ENTER THE MAIN BURNER OR INTERFERE WITH THE BURNING OF THE LOG SET.

IMPORTANT

For all valves, the air **MUST** be purged from the gas line before the ODS pilot will light properly. The time taken to do this will depend on the length of gas line from the meter to the unit and the length of time since the unit or gas line was last used (in the case of non-use during warm weather for example). It may take from 3-15 minutes before all the air is purged and the ODS pilot will light properly. This is done using the method for lighting the ODS pilot, but holding in the control valve for a longer period. Follow the relevant LIGHTING INSTRUCTIONS in this manual for the specific valve type.

EMBER PLACEMENT

The glowing embers are supplied in the larger of the two ember bags containing the darker embers (Fig. 20-2). It is important that only the embers supplied be used and that no additional glowing embers be added. **Open the bag and spread the embers loosely along the entire length of the ember burner (Fig. 20-3) from left to right on the burner and on the vertical portion of the ember burner. Break up any clumps that may have developed during shipment and make sure the embers are spread evenly over the entire area.** Failure to follow these instructions will result in unsafe operation.

PLATINUM EMBERS (BRYTE COALS) PLACEMENT

With the glowing embers spread evenly across the entire length of the ember burner, open the bag of bryte coals containing a smaller amount of the lighter colored embers (Fig. 20-4) and pinch off (Fig. 20-5) six (6) one inch (1") pieces of the bryte coals. Place the six (6) pieces on top of the glowing embers in the spots shown in Fig. 20-6.

DO NOT ADD ANY ADDITIONAL EMBERS TO THIS LOG SET. ANY ADDITIONAL EMBERS MAY CAUSE UNSAFE OPERATION.

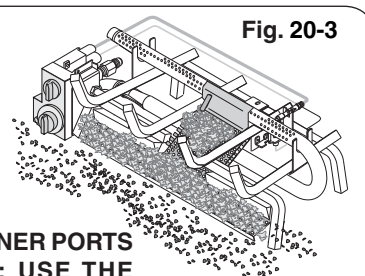
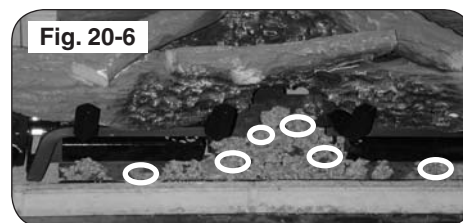
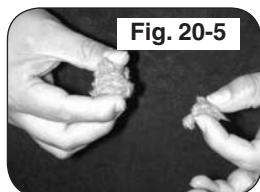

NOTE: DO NOT COVER BURNER PORTS WITH LAVA ROCK; USE THE SUPPLIED EMBERS ONLY

LOG PLACEMENT

Carefully follow the detailed instructions on the next page for correct log placement.

WARNING

Failure to position the parts in accordance with these diagrams or failure to use only parts specifically approved with this heater may result in property damage or personal injury.

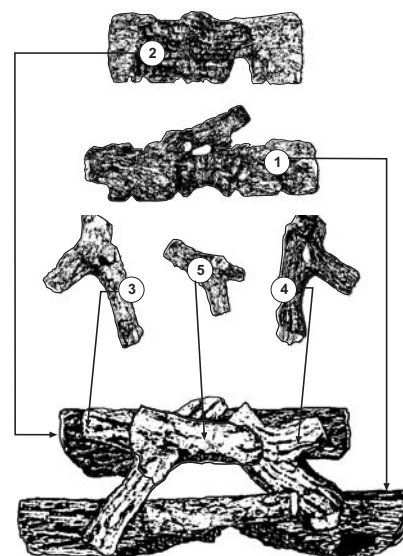
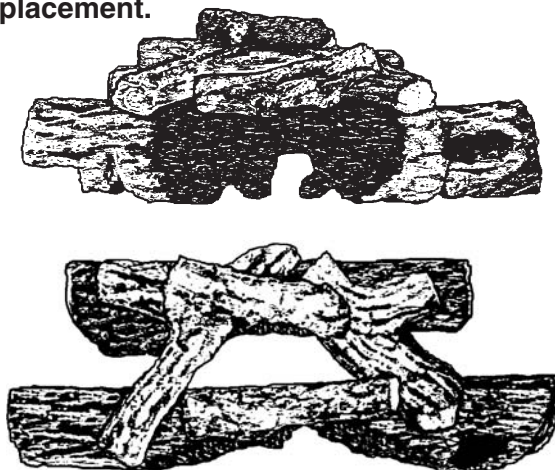

INSTALLATION - LOG PLACEMENT

Maintain log position as shown AT ALL TIMES.

REFRACTORY LOG PLACEMENT

Log placement is critical to ensure stability of the logs and proper performance of the gas log set. Be sure to follow log placement instructions carefully!

1. Each log in the vent-free gas log set is numbered to aid in the log placement procedures. Set the **REAR** log on the grate so that the rear of the main burner bracket fits into the 2 locating grooves in the **front face** of the log (see Fig. 21-1, No. 2). The back of the **FRONT** log (Fig. 21-1, No. 1) fits tight up to the front of the main burner bracket on the grate (see Fig. 21-2).
2. Check that the logs are centered left to right.
3. Position the intermediate logs #3 and #4 on top of the bottom logs. Locate the logs so that each log rests in the corresponding slots on the bottom front log and bottom rear log (see Fig. 21-3).
4. Position the top log #5 on the top of the intermediate logs. Locate the top log by placing it into the slots of the intermediate logs (see Fig. 21-4).

After setting the logs into position, as described above, ensure each is properly and firmly seated. The vent-free gas log set will not function as intended if the logs are not correctly positioned. When placed properly, the flames will not strike any portion of logs #3, 4 or 5. Periodically check the positioning of all logs to ensure proper log placement and stability. If any flame is striking any of the logs, recheck log placement. Adjust to conform with instructions. **There should be no flame impingement on these logs.**

CHFR-16/18" LOG SET SHOWN

Fig. 21-1

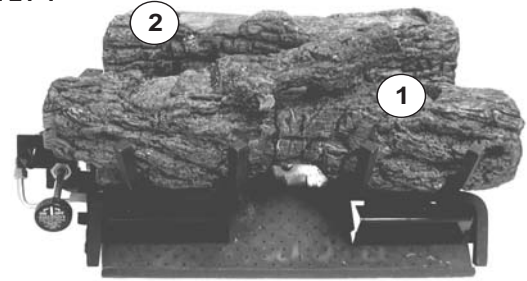
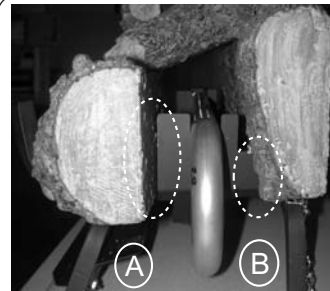

Fig. 21-2



(A)
Ensure back of **FRONT** log is snug up to bracket

(B)
Ensure notches in face of **REAR** log slide over rear of bracket

Fig. 21-3

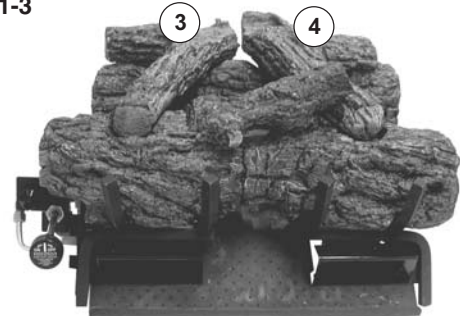
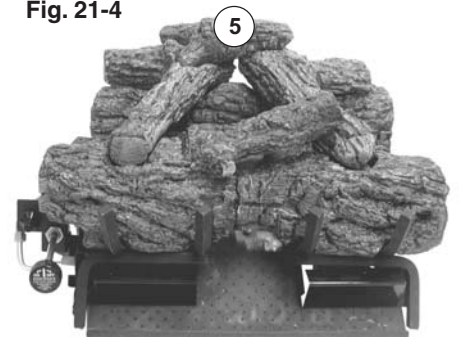

Fig. 21-4



CAUTION: BURN HAZARD. LOGS WILL REMAIN HOT FOR SOME TIME AFTER USE.

YOU MUST MAINTAIN THE LOG LAYOUT AS SHOWN TO ENSURE PROPER OPERATION OF THE LOG SET. IF YOU NEED TO REPOSITION ANY LOG TO MAINTAIN THE PROPER LAYOUT, USE HEAT RESISTANT GLOVES OR ALLOW LOGS ADEQUATE TIME TO COOL BEFORE HANDLING.

WOOD CHIP PLACEMENT

The designer wood chip provided with the 15(M)(P) and 01V(P) log sets is for aesthetics and does not affect operation of the G10 Series vent-free gas log set. The wood chip should be placed in front of the valve, with at least a 1/2 inch between it and the valve (see Fig. 21-5 and Fig. 21-3).

Note: The wood chip may be **HOT** during and directly after operation of the gas log set. Do not place the wood chip on or in the log set.



Fig. 21-5

INSTALLATION: DAMPER CLAMP (IF APPLICABLE)

The damper clamp with hex bolt (Fig. 22-1) is provided as a means to prevent full closure of the damper blade. The clamp is easily attached to most damper blades with pliers or a wrench, and must be permanently installed. The clamp is designed to prevent accidental closure of the damper when installed as illustrated (Fig. 22-2 and Fig. 22-3). Should the clamp not fit, or fail to provide the permanent vent opening specified in Table 3-1, have a permanent stop installed, remove the damper blade, or have the damper cut to provide the minimum permanent opening required.

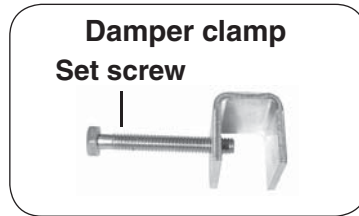

Fig. 22-1

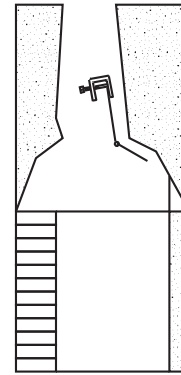

Fig. 22-2

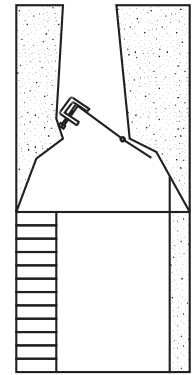

Fig. 22-3

CLEANING AND SERVICING SAFETY INFORMATION

Note: Regular cleaning and servicing will be necessary to ensure proper ODS pilot operation and proper burn characteristics.

- A. Always shut off the gas to the unvented gas log set while performing service work.
- B. Allow the unvented gas log set to cool before servicing.
- C. **Installation, service, and repair must be done by an NFI Certified or other qualified professional service technician. The appliance MUST be inspected before use, and cleaned at least annually to prevent burner shutdown, sooting, odors, etc. by a qualified professional service technician. It must be checked for clean burning operation and proper ODS pilot appearance, with the correct tools to service this unit. More frequent cleaning may be required.** Excessive lint can build up on this unit from carpeting, bedding material, pet hairs, or other particles in the air. It is imperative that all control components and compartments, burner(s), and circulating air passageways of the appliance be kept clean and free of all obstructions. The ODS pilot is especially sensitive to a dirty environment and will not function properly if dirty. Make certain all air openings are clean and free of obstructions, including:
 1. The air intake opening on the ODS pilot assembly.
 2. The ODS pilot opening.
 3. The air shutters on both the front/bottom ember burner and the rear/top main burner.
 4. The flash tube and its corresponding carryover ports. Obstructions in or around the flash tube may result in the ember burner not lighting and/or an intermittent popping noise from the flash tube.

WARNING: Failure to keep the primary air openings of the burner(s) clean may result in sooting and property damage.

5. All of the ports on both the front/bottom ember burner and the rear/top main burner. (See the CLEANING AND SERVICING section.)
- D. **Any safety screen or guard removed for servicing must be replaced prior to operating this gas log set.**
- E. Decorative wood chip (if included) must be placed at least a 1/2 inch away from burner controls to avoid damaging the controls by overheating due to heat reflection (see Fig. 22-6).

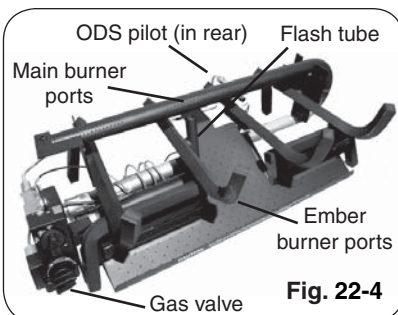

Fig. 22-4

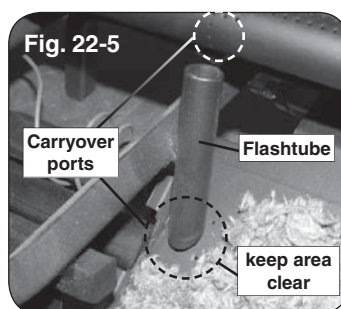

Fig. 22-5

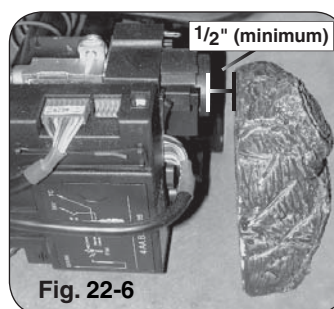

Fig. 22-6

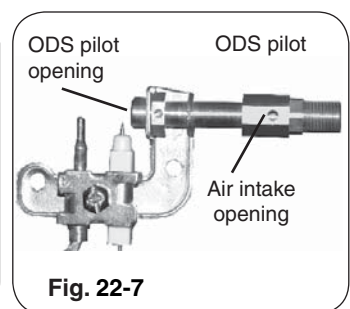

Fig. 22-7

CLEANING AND SERVICING

Only limited cleaning will be required under normal use of the unvented gas log set.

TO CLEAN THE LOG SET

1. Remove the log set and embers. Use a vacuum cleaner to remove loose particles from all surfaces of the log set. Do not use cleaning fluids.
2. Dust the grate, the assembly, and the burners. Using a compressed air duster (commonly available at computer, electronic, or office supply stores); blow through the flash tube, its corresponding carry over ports, and all of the burner ports. See Fig. 22-4 and 22-5 on the previous page for locations.
3. Reinstall the log set and embers as instructed in this manual.

If, after a period of use, the flames start to exhibit unusual shapes and behavior, or the burners fail to ignite smoothly, the burner ports may require some cleaning. If this happens, it is preferable to contact the nearest dealer to get the unvented gas log set serviced.

Do not remove the rating plates or the warning tags. These are an integral safety and identification component of this appliance.

During periods of heavy use, inspect the unvented gas log set frequently for evidence of sooting. If sooting is present, discontinue use until the source of sooting is corrected.

CLEANING AND SERVICING THE ODS PILOT

Periodic cleaning and maintenance of the unvented gas log set is recommended to ensure that the log set operates properly. Cleaning of the ODS pilot system is an important part of the maintenance program.

This ODS pilot cleaning procedure must be performed by a qualified professional service technician familiar with the specific characteristics of the log set.

1. Turn the unvented gas log set to the OFF position and allow it to cool. Inspect the ODS pilot area (see Fig. 23-1) for any visual contamination or debris (usually lint, hair, spider webs, or small insects). Lightly brush off all external surfaces while vacuuming loosened debris from the ODS pilot opening. **Be careful not to brush any foreign material into the ODS pilot opening.**
2. Clean out the air intake opening (see Fig. 23-1) by lightly brushing around the opening while vacuuming.
Note: It is very important that the air intake opening be kept clear of debris. Should the opening become blocked, the ODS pilot system will not operate properly.
3. Light the ODS pilot according to the relevant LIGHTING INSTRUCTIONS page. Periodically verify the ODS pilot flame appears as shown in the CHECKING THE ODS PILOT FLAME APPEARANCE section.
4. If the ODS pilot flame does not burn as indicated in the instructions, extinguish the ODS pilot by turning the valve to the full **OFF** position. Using a compressed air duster, insert the flexible nozzle through the air intake opening, ensuring that the nozzle is pointed toward the ODS pilot opening (see Fig. 23-1). Blow air through the intake opening to clear out any debris that may be in the system.
5. Relight the ODS pilot and inspect it to be sure it is burning as shown in the instructions. If not, extinguish the ODS pilot and **turn off the gas supply to the gas log set.** Using an adjustable or a 1/4" wrench, disconnect the ODS pilot gas line (see Fig. 23-1) from the valve.
6. Insert the flexible nozzle of the compressed air duster and blow air into the input end of the ODS pilot gas line to remove any blockages. **Do not blow air directly into the ODS pilot opening. Blow air in the direction of the gas flow.**
7. Reinstall the ODS pilot gas line and check for leaks.
8. Light the ODS pilot to make sure it is operating properly (see LIGHTING INSTRUCTIONS).
9. If the ODS pilot still does not operate properly, the ODS pilot may need to be replaced with the same model as the one on the unvented burner.

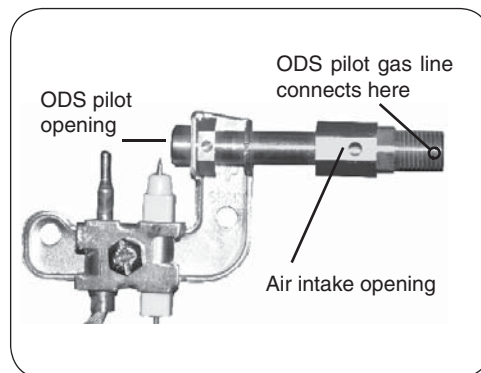

Fig. 23-1

OPERATING THE UNVENTED GAS LOG SET

Observe the flames. The main burner flames should be blue at the base and a combination of blue/yellow at the body and at the tips. They should be 5" to 8" above the logs, with the center flame being the tallest (see Fig. 24-1). Front flames in the ember burner should be 1/4" above the embers.

Every Real-Fyre unvented gas log set leaves the factory tested and quality checked to ensure that it has been manufactured to the strict specifications to which it was submitted and approved for certification. This check includes an operational test to ensure both satisfactory combustion and operation.

Each installation site for any unvented appliance presents its own unique combustion environment. Specific factors such as weather-tightness of the home, size of the room in which the log set is installed, central heating, ceiling fans, altitude, drafts, pet hair, carpet lint, dryer lint, the size of the fireplace, paint or soot inside the fireplace, etc. all have an influence on the proper operation of an unvented appliance and its ODS pilot system. A normally operating unvented log set will demonstrate the following characteristics:

- A lively, realistic flame and front ember glow. The flame will be blue/yellow on the front burner and on the rear burner.
- Clean-burning combustion that will produce no soot or smoke after normal break-in.
- Production of no odor, other than normal odors associated with the combustion of propane or natural gas.
- Production of water vapor. Water vapor helps to increase indoor humidity, which may be beneficial during the dry heating season.

If you operate the unvented gas log set fueled by propane gas, operating characteristics may vary as the fuel in the tank approaches empty (less than 1/4 full). Sooting and other increases in combustion by-products will occur. Turn off the log set and refill the propane tank.



Fig. 24-1

CHECKING THE ODS PILOT FLAME APPEARANCE

WARNING: NO ADJUSTMENTS ARE TO BE MADE TO THE ODS PILOT SYSTEM. TAMPERING WITH THIS SYSTEM CAN BE EXTREMELY HAZARDOUS.

When installing the burner assembly, it is important to visually check the ODS pilot flame and the burner flames.

1. The ODS pilot flame must be present when the burner is operating. The flame should touch the top of the thermocouple tip (Fig. 24-2 and Fig. 24-4).
2. If the ODS pilot flame does not touch the top of the thermocouple tip, then the main burner will not function properly (see Fig. 24-3 and Fig. 24-5 for incorrect ODS pilot flame).
3. With the burners off and the ODS pilot flame off, and the assembly cool, check the burner assembly, air intake openings on the ODS pilot, and air shutter openings on the burner for any blockages that could affect the operation of the ODS pilot flame.

ODS Pilot for Manual, 01, and 15 valve

(NG shown)

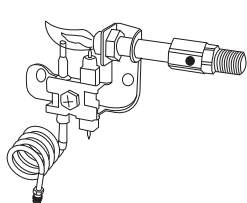

Correct ODS pilot flame

Fig. 24-2

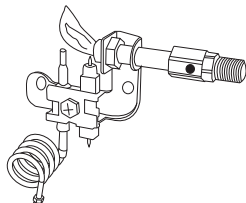

Incorrect ODS pilot flame

Fig. 24-3

ODS Pilot for 12 valve

(NG shown)

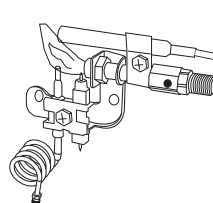

Correct ODS pilot flame

Fig. 24-4

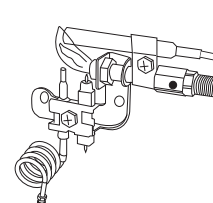

Incorrect ODS pilot flame

Fig. 24-5

LIGHTING INSTRUCTIONS - SERIES 15 VALVE

FOR YOUR SAFETY, READ BEFORE LIGHTING

WARNING

If you do not follow these instructions exactly, a fire or explosion may result, causing property damage, personal injury, or loss of life.



Do not use this appliance if any part has been underwater. Immediately call for a qualified professional service technician to inspect the appliance and to replace any part of the control system and any gas control that has been underwater.

The Real-Fyre® burner system has an ODS pilot. When starting the ODS pilot, follow these instructions exactly.

BEFORE LIGHTING, smell all around the gas burner system area for gas. Be sure to smell next to the floor, as some gas is heavier than air and will settle on the floor. IF YOU SMELL GAS, FOLLOW THE INSTRUCTIONS ON P. 1.

Use only your hand to push in or turn the gas control knob. Never use tools. If the knob will not push in or turn by hand, don't try to repair it. Call a qualified professional service technician. Force or attempted repair may result in fire or explosion.

LIGHTING THE ODS PILOT



1. Turn the ignitor control knob (Fig. 25-1) on the burner control valve assembly to the side of the burner pan counterclockwise  so that the narrowing part of the knob moves from the **OFF** position, slightly toward **IGN**, until reaching the stop.
2. Press the ignitor control knob in and hold in for five seconds (only ODS pilot gas will flow).
3. Continue pressing in while turning the ignitor control knob further counterclockwise  toward the **PILOT** position, until you hear a click. The click is an indication that the piezo ignitor has been activated.

Note: If the spark from the piezo ignitor does not light the ODS pilot, repeat steps 2 & 3 until the ODS pilot lights.

4. Continue to hold the ignitor control knob in the **PILOT** position for 30 seconds after the ODS pilot has been lit to allow the thermocouple to detect the ODS pilot flame.



Note: The ODS pilot flame should always be present when the burner system is in operation, and should just envelop the tip of the thermocouple.

IGNITING THE MAIN BURNER

1. When the ODS pilot flame is stable, release the ignitor control knob and turn counterclockwise  to the **ON** position to enable the main burner.
2. Turn the flame-height control knob (Fig. 25-3) counterclockwise  to the fully **ON** position

(Fig. 25-4) to ignite the burner at maximum BTU. After the main burner ignites, adjust the flame height as indicated below.

ADJUSTING THE FLAME HEIGHT

1. To adjust the flame, turn the flame-height control knob (Fig. 25-3) counterclockwise  to increase the flame height, or clockwise  to decrease the flame height, until the flames have the desired characteristics.
2. When you are finished enjoying your fire, turn the flame-height control knob to **OFF**. The ODS pilot will remain lit. The burner system can be relit by rotating the flame-height control knob toward **ON**.

SHUTTING OFF THE ODS PILOT

If you do not plan on using your burner system for an extended period, you may elect to extinguish the ODS pilot. To do this, rotate the flame-height control knob to the **OFF** position and then rotate the ignitor control knob to the **OFF** position (Fig. 25-1).

Important: When shutting your burner down, be sure to TURN THE FLAME FULLY OFF (to **PILOT** or **OFF**). Make sure the burner is completely off for one minute before relighting.

If this unit was shipped with a remote, or if a remote system was installed later, read and follow the separate remote instructions to operate the burner remotely.

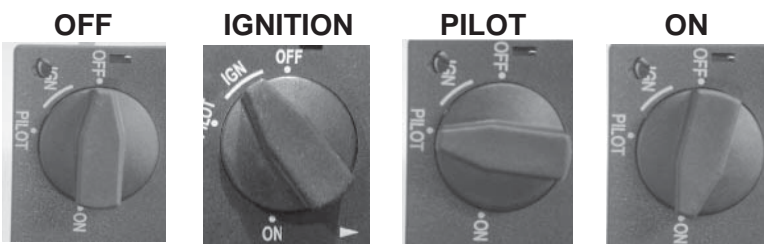

Gas valve operating positions

Fig. 25-1

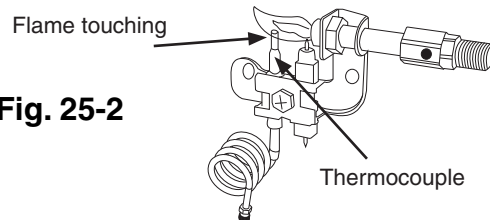

Fig. 25-2

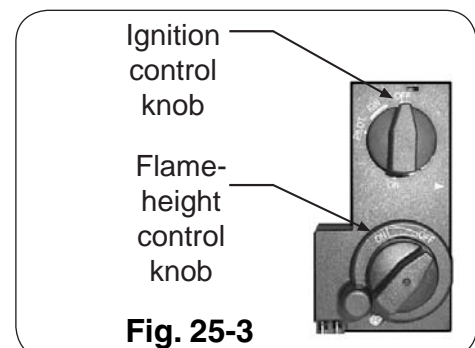

Fig. 25-3

Flame-height control knob



OFF



ON

Fig. 25-4

LIGHTING INSTRUCTIONS - MANUAL VALVE

FOR YOUR SAFETY, READ BEFORE LIGHTING

WARNING: If you do not follow these instructions exactly, a fire or explosion may result, causing property damage, personal injury, or loss of life.

Do not use this appliance if any part has been underwater. Immediately call for a qualified professional service technician to inspect the appliance and to replace any part of the control system and any gas control that has been underwater.

The Real-Fyre® burner system has an ODS pilot. When starting the ODS pilot, follow these instructions exactly.

BEFORE LIGHTING, smell all around the gas burner system area for gas. Be sure to smell next to the floor as some gas is heavier than air and will settle on the floor. IF YOU SMELL GAS, FOLLOW THE INSTRUCTIONS ON P. 1.

Use only your hand to push in or turn the gas control knob. Never use tools. If the knob will not push in or turn by hand, don't try to repair it. Call a qualified professional service technician. Force or attempted repair may result in fire or explosion.

LIGHTING THE ODS PILOT

1. Push in the gas control knob (Fig. 26-1) slightly and turn clockwise ↻ to **OFF**.

Note: The burner control knob cannot be turned from **PILOT** to **OFF** unless the handle is pushed in slightly. Do not force.

2. Turn the control knob on the gas valve counterclockwise ↺ to **PILOT**.

Note: The burner control knob cannot be turned from **OFF** to **PILOT** unless the handle is pushed in slightly. Do not force.

Wait five minutes to clear out any gas. If you then smell gas, STOP! Notify your gas supplier or the fire department immediately. If you don't smell gas, go on to step 2.

3. Push in on the control knob all the way and hold in. Immediately light the ODS pilot with a long-neck butane lighter or press in ignitor button (Fig. 26-1) to light the ODS pilot. Continue to hold the control knob in for approximately 30 seconds after the ODS pilot is lit. Release the knob, and it will pop back out. The ODS pilot should remain lit. If it goes out, repeat steps 4 through 5.
- If the knob does not pop back out when released, stop and immediately call your service technician or gas supplier.
 - If the ODS pilot will not stay lit after several tries, follow the instructions for SHUTTING OFF THE ODS PILOT and call your service technician or gas supplier.

IGNITING THE MAIN BURNER

1. Push in slightly and rotate your manual control knob in a counterclockwise ↺ direction to the **ON/HIGH** position (first stop past **PILOT** position, see Fig. 26-2). The main burner will ignite at maximum BTU.

ADJUSTING THE FLAME HEIGHT

1. To lower the setting, push in slightly and continue to turn in a counterclockwise ↺ direction. When you reach the stop, your burner is at minimum **LOW** position.
2. To turn off *the main burners only*, push in slightly and rotate the manual control knob clockwise to the **PILOT** position. The **ODS pilot flame will remain lit**.

SHUTTING OFF THE ODS PILOT

If you do not intend to use your log set for an extended period of time, you may elect to turn the manual control knob to the **OFF** position. This will extinguish the ODS pilot. The next time you use the set, you will have to light the ODS pilot as described in LIGHTING THE ODS PILOT.

Note: When shutting your log set down, be sure to **TURN THE FLAME COMPLETELY TO THE OFF POSITION. Make sure the burner is completely off for one minute before relighting!**

If this unit was shipped with a remote, or if a remote system was installed later, read and follow the separate remote instructions to operate the burner remotely.

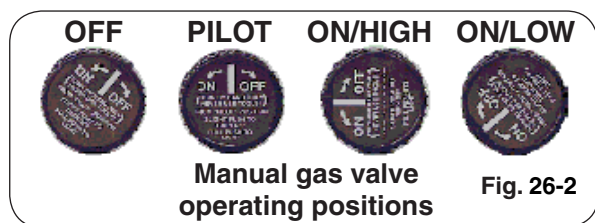
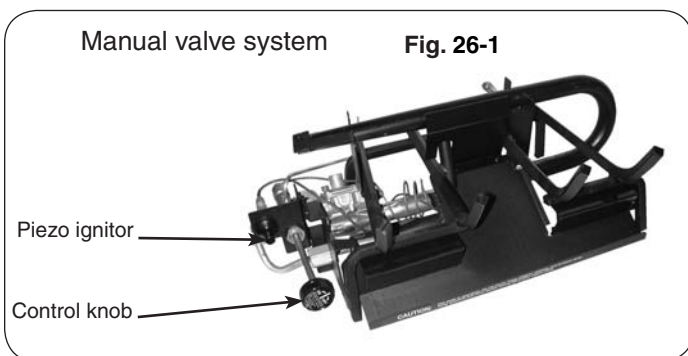

WARNING: NO ADJUSTMENTS ARE TO BE MADE TO THE ODS PILOT SYSTEM. TAMPERING WITH THIS SYSTEM CAN BE EXTREMELY HAZARDOUS.

LIGHTING INSTRUCTIONS - SERIES 12 VALVE

FOR YOUR SAFETY, READ BEFORE LIGHTING

WARNING

If you do not follow these instructions exactly, a fire or explosion may result, causing property damage, personal injury, or loss of life.

Do not use this appliance if any part has been underwater. Immediately call for a qualified professional service technician to inspect the appliance and to replace any part of the control system and any gas control that has been underwater.

The Real-Fyre® burner system has an ODS (Oxygen Depletion Sensor) pilot that can be lit by using the built in piezo ignitor switch on the burner, or by hand using a match or long necked lighter. When lighting the ODS pilot, follow these instructions exactly.

BEFORE LIGHTING, smell all around the burner area for gas. Be sure to smell next to the floor as some gas is heavier than air and will settle on the floor. **IF YOU SMELL GAS, FOLLOW THE INSTRUCTIONS ON P. 1.**

Use only your hand to push in or turn the gas control knob. Never use tools. If the knob will not push in or turn by hand, don't try to repair it. Call a qualified professional service technician. Force or attempted repair may result in fire or explosion.

LIGHTING THE ODS PILOT

To read the safety valve control knob (Fig. 27-1), read the marking nearest the teardrop-shaped metal pointer.

1. If the safety valve control knob is in the **PILOT** position, push in slightly on the knob and rotate it clockwise ↻ to the **OFF** position.
2. Release knob and wait five minutes.
3. Turn safety valve knob counterclockwise ↺ to the **PILOT** position. (Only the ODS pilot gas will flow when the knob is pushed in.)
4. Push and hold the safety valve knob fully in and push in the piezo ignitor button several times until the ODS pilot lights.
5. Hold the safety valve knob in for approximately 60 seconds before releasing.
6. **If the ODS pilot does not stay lit**, turn the safety valve knob clockwise ↻ to the full **OFF** position. Wait five minutes, then repeat steps 3 through 5.

IGNITING THE MAIN BURNER

With the ODS pilot lit, turn the safety valve knob counterclockwise ↺ to the **ON** position. Flip the switch control to the **ON** position and the burner will light. Refer to the PARTS LIST for the switch location.

SHUTTING OFF THE MAIN BURNER

Flip the switch control clockwise ↻ to the **OFF** position. The ODS pilot will remain lit.

SHUTTING OFF THE ODS PILOT

Be sure the switch control is **OFF** and depress and turn the safety valve knob clockwise ↻ to the **OFF** position.

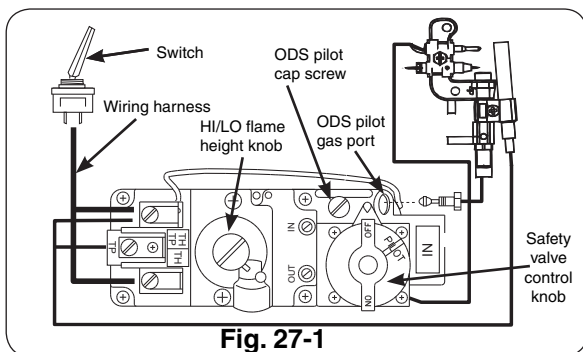

Fig. 27-1

When shutting your burner down, be sure to TURN THE FLAME FULLY OFF (to **PILOT** or **OFF**). Make sure the burner is completely off for one minute before relighting.

ADJUSTING THE ODS PILOT

- a. The ODS pilot flame should encircle the generator tip, and is preset at the factory (Fig. 27-2). Ordinarily, the ODS pilot will not require field adjustment.
- b. If adjustment is necessary, remove the cap screw (Fig. 27-1) and turn the smaller gas adjustment screw inside counterclockwise ↺ to increase the ODS pilot flame, and clockwise ↻ to decrease the ODS pilot flame. Replace the cap screw.

MAINTENANCE

Your pan burner is equipped with a safety ODS pilot that will shut off the gas supply in case the ODS pilot is not burning or functioning properly. Make sure the ODS pilot is adjusted properly and that the generator spade clips are tightly connected to the terminal screws on the valve. If the ODS pilot will not stay lit, call your local gas utility or gas supplier.

A periodic check of the following should be performed at least annually by a qualified professional service representative:

1. Valves and switch for proper operation.
2. Flue system for rust, damage, or leaks.
3. Damper operation.
4. Orifices for dirt or other foreign matter.
5. Visual check on the burner.

If this unit was shipped with a remote, or if a remote system was installed later, read and follow the separate remote instructions to operate the burner remotely.

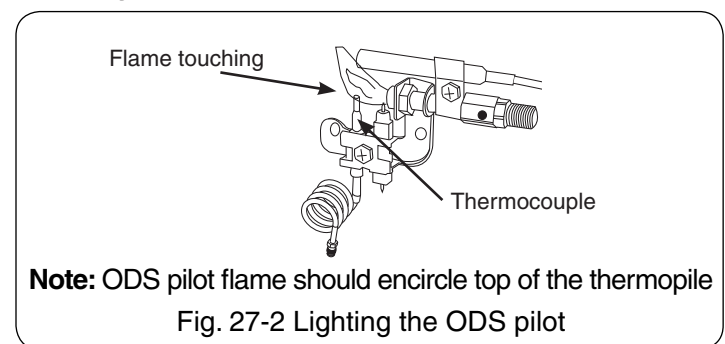

Note: ODS pilot flame should encircle top of the thermopile
Fig. 27-2 Lighting the ODS pilot

LIGHTING INSTRUCTIONS - 01V(P) VALVE

FOR YOUR SAFETY, READ BEFORE LIGHTING

WARNING: If you do not follow these instructions exactly, a fire or explosion may result, causing property damage, personal injury, or loss of life.

Do not use this appliance if any part has been underwater. Immediately call for a qualified professional service technician to inspect the appliance and to replace any part of the control system and any gas control that has been underwater.

The Real-Fyre® burner system has an ODS pilot. When starting the ODS pilot, follow these instructions exactly.

BEFORE LIGHTING, smell all around the gas burner system area for gas. Be sure to smell next to the floor, as some gas is heavier than air and will settle on the floor. IF YOU SMELL GAS, FOLLOW THE INSTRUCTIONS ON PAGE 1.

Use only your hand to push in or turn the gas control knob. Never use tools. If the knob will not push in or turn by hand, don't try to repair it. Call a qualified professional service technician. Force or attempted repair may result in fire or explosion.

LIGHTING THE ODS PILOT



1. Locate your electronic control valve (see PARTS LIST, Item 2). Turn the control arrow to **MAN** for manual mode (see Fig. 28-1).
2. Press the ON/OFF switch from **O** to **I** (see Fig. 28-1). Using a small bladed screwdriver or similar, press and hold the button within the hole on the control (see Fig. 28-2). Using a long-neck butane lighter, ignite the ODS pilot flame. Hold in the button for about 1 minute (or longer if first use or after a long period of non-use).
3. The ODS pilot flame should now remain lit. It should always be present when the gas log set is in operation and just envelop the tip of thermocouple. If the ODS pilot light goes out, repeat steps 1-2. If the ODS pilot will not stay lit after several tries, follow the instructions TO TURN OFF GAS TO APPLIANCE in your owner's manual and call your service technician or gas supplier.

IGNITING THE MAIN BURNER

1. When the ODS pilot flame is stable (remains lit, beeping stops), turn the control knob to **ON**. Turn the flame height control knob counterclockwise  past **ON**; gas will flow to the main burner, and the main burner will ignite. The ember burner will ignite shortly afterward.

ADJUSTING THE FLAME HEIGHT

1. To adjust the flame height, turn the flame height control knob (see Fig. 28-3) until the desired flame

height is reached (counterclockwise  to increase, clockwise  to decrease).

2. To turn off *just the main burners*, turn the flame height control knob fully clockwise  until flame is extinguished. **The ODS pilot flame will remain lit.**

SHUTTING OFF THE ODS PILOT

If you do not plan on using your log set for an extended period you may elect to extinguish the ODS pilot. To do this, press the I/O switch on the valve to **O**. This will completely shut down the log set (main burners and ODS pilot will extinguish). This will require that you relight the ODS pilot before you use the log set again. To do so, follow steps 1-2 above. Always turn flame height control knob to the **OFF** position when shutting it down.

Note: When completely shutting your log set down, be sure to TURN THE (I/O) SWITCH ON THE VALVE TO O (OFF). Make sure the burner is completely off for 1 minute before relighting!

To operate the burner using a remote handset and receiver, follow the instructions supplied with the remote.

CHECKING THE ODS PILOT FLAME

1. The ODS pilot flame must be present when the burner is operating. The flame should touch the top of the thermocouple tip (Fig. 28-4).
2. If the ODS pilot flame does not touch the top of the thermocouple tip, then the main burner will not function properly (see Fig. 28-5 for incorrect ODS pilot flame).
3. With the burners off, the ODS pilot flame off, and the assembly cool, check the burner assembly, air intake opening on the ODS pilot, and air shutter openings on the burner for any blockages that could affect the operation of the ODS pilot flame.

ODS PILOT FOR REMOTE VALVES

(NG shown)

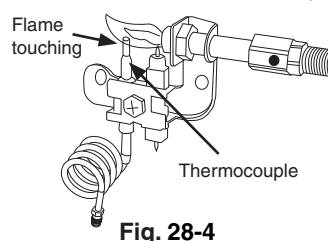

Correct ODS pilot flame

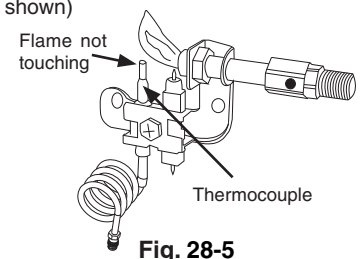

Incorrect ODS pilot flame

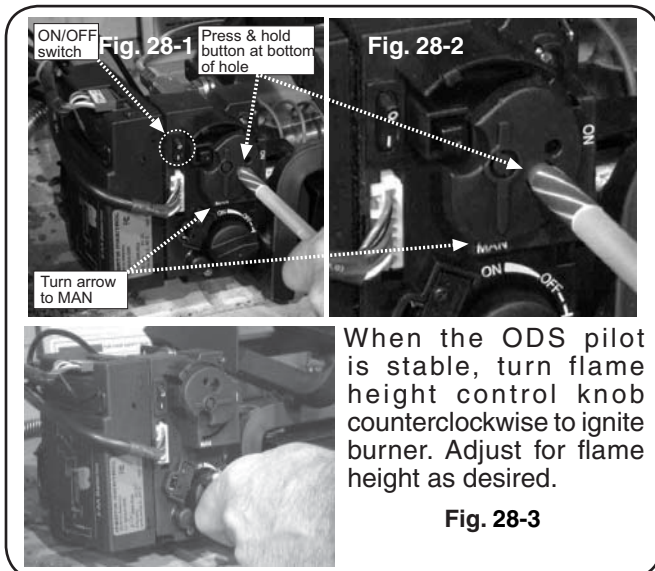

When the ODS pilot is stable, turn flame height control knob counterclockwise to ignite burner. Adjust for flame height as desired.

Fig. 28-3

TROUBLESHOOTING

- ONLY A QUALIFIED PROFESSIONAL SERVICE PERSON SHOULD SERVICE AND REPAIR THIS APPLIANCE.
- TURN OFF UNIT AND ALLOW TO COOL BEFORE TROUBLESHOOTING

1) BURNER SHUTTING DOWN DURING OPERATION

| POSSIBLE CAUSE | SOLUTIONS |
|---|---|
| A. Insufficient or excessive gas pressure | <p>A1. Check gas pressure (check with local gas company). For natural gas, pressure must be minimum 5" w.c. at fireplace with burner operating. Maximum inlet gas pressure is 10.5", w.c. Reading at inlet pressure tap (farthest to valve inlet) on remote-capable valves burners should be 5" w.c. (minimum). With the knob on high, maximum inlet pressure is 10.5" w.c.</p> <p>A2. Other gas appliances may be on the same gas line, dropping gas pressure to the burner system. Check pressures with everything operating to ensure adequate pressure.</p> |
| B. Foreign debris in or around the fireplace and around the air intakes of the ODS pilot | B. Dust, carpet fibers, paper, spider webs, pet hair, etc. in fireplace or on burner assembly can affect operation of burner and ODS pilot assembly. Clean out debris and vacuum around burner for accumulated dust. Vacuum or use compressed air to clean out the ODS pilot assembly area, air shutter hole, burner orifice(s), and ODS pilot air intake openings. Blockage in this area will affect the operation of the ODS pilot assembly. |
| C. Room size (unconfined space) | C. 50 cu. ft. is required for every 1,000 BTU. Multiply the room's length x width x height by 20 (L x W x H x 20). If resulting number is less than the BTU rating of the burner, ODS pilot outages may occur. Provisions for adequate combustion and ventilation air must be made (see VENTILATION AND COMBINED SPACE SAFETY INFORMATION). |
| D. Flue area, fireplace, or damper dirty from soot | D. Clean around, above, and under damper thoroughly. Clean fireplace, removing loose material, including soot and creosote. |
| E. Fans, furnaces, air conditioning vents, returns, or fireplace outside air vents near or blowing into fireplace may create drafts, altering flame patterns | E. Eliminate drafts by closing heating and air conditioning vents, returns, and closing outside air vents. Fans blowing directly into the fireplace should be turned off when set is operating. |
| F. Blockages on burner | F. Vacuum any Lava Granules or material that may have fallen onto burner port area. |
| G. Fireplaces with high top cavities can accumulate by-products of combustion, which can start recirculating, causing shutdown | G. Open window or damper slightly. Move burner forward if possible, or otherwise increase ventilation. |
| H. Insufficient air circulation | H1. Check log placement, ember placement, Bryte Coals™ placement, and sizing of burner system (check your owner's manual for proper placement and requirements). Reposition burner closer to the front of fireplace. (Note: Do not place burner too close to combustibles.) (See INSTALLATION SAFETY GUIDELINES section.) |
| | H2. Check for sunken fireplace, excessive lava rock, or other accessories packed too tightly against burner or high bottom lip on glass door. Open window or damper slightly. |
| I. Fireplace too small for unit | I. Ensure minimum requirements are met (see FIREPLACE SIZE REQUIREMENT section). |
| J. At high altitude, too much heat or moisture can cause ODS pilot to shut down system | J. Open a window or the damper slightly or otherwise increase the ventilation. Your set may not be certified for use over 2,000 feet. Check your owner's manual. |
| K. ODS pilot flame lifting off thermocouple/generator | K. Check gas pressure (see item A1 in this table). |
| L. Pilot (remote-capable) | L. Contact your dealer for instructions on replacement. |
| M. Soot inside burner | M. Take burner tube out of unit and shake it or tap it to loosen soot inside burner. Clean thoroughly and place burner tube back onto unit. |
| N. Log placement | N. Your logs may have notches for correct placement. The burner may have brackets for correct placement. Make sure log set is placed in proper position (see LOG PLACEMENT) so there is no flame impingement on the log set. |

TROUBLESHOOTING (Cont.)

POSSIBLE CAUSE

SOLUTIONS

2) ODS PILOT WILL NOT LIGHT

| | |
|---|---|
| A. ODS pilot flame lifting off thermocouple/generator | A. Check gas pressure. |
| B. Piezo spark not lighting ODS pilot | B. Check to make sure piezo is sparking when pressing / turning ignitor. (Note: You may need to press / turn ignitor several times to ignite ODS pilot.) See LIGHTING INSTRUCTIONS section. |
| C. Gas supply off/manual shutoff valve closed | C. Turn on gas supply or open manual shutoff valve. |
| D. Air in gas line | D. Hold control knob to bleed the line and repeat LIGHTING INSTRUCTIONS until air is removed. |

3) HIGH CO - CARBON MONOXIDE DETECTORS IN HOME TURNING ALARM ON

| | |
|-------------------|---|
| A. High CO levels | A. TURN OFF UNIT IMMEDIATELY. |
| | B. Call a qualified professional service technician or your gas supplier. |

4) CONDENSATION

| | |
|--|--------------------------------------|
| A. High room humidity and cold walls or windows will create condensation in room | A. Open a window or damper slightly. |
|--|--------------------------------------|

5) LOW FLAME HEIGHT

| | |
|-----------------------------|--------------------------|
| A. Low gas pressure | A. Check gas pressure. |
| B. Propane tank running low | B. Fill tank completely. |

6) BURNER NOT BURNING EVENLY

| | |
|--|---|
| A. Top burner lights; bottom burner has delayed ignition or does not light | A1. Check gas pressure. Can be caused by too small a gas line (see ANSI 223.1/NFPA 54 Piping Guidelines). A2. Low propane fuel gas level. Vacuum burner tube for soot blockage and fill propane tank. A3. Flash tube (if present) blocked. Clear blockage. |
| B. Burner orifice(s) clogged | B. Clean burner orifice(s). |

7) NO SPARK AT ODS PILOT WHEN IGNITOR IS PRESSED / TURNED

| | |
|---|--|
| A. Ignitor electrode wire loose | A. Check wiring and reconnect any loose wiring |
| B. Ignitor electrode positioned incorrectly | B. Contact your dealer for service |

8) ODORS

| | |
|---|---|
| A. New burner system (break-in period) | A. Burn unit for four to six hours with damper, doors, or windows open. Allow odors to dissipate. |
| B. Odors created by aerosol sprays, detergents, household chemicals, and insecticides | B. When these odors are drawn into the fireplace, this may cause objectionable odors. Thoroughly ventilate the area before restarting your burner system. |
| C. Gas leak | C. Locate gas leak and correct all leaks. |

TROUBLESHOOTING (Cont.)

| POSSIBLE CAUSE | SOLUTIONS |
|---|--|
| 9) SOOTING | |
| A. Low gas pressure | A. Check gas pressure. |
| B. Drafts in room | B. Eliminate drafts by closing heating and air conditioning vents, returns, and outside air vents. Fans blowing directly into fireplace should be turned off when system is operating. |
| C. Air shutter(s) blocked | C. Burner air shutter(s) are blocked with debris. Vacuum debris in and around burner area. |
| D. Using a product other than Real-Fyre® gas logs with burner | D. Make sure only Real-Fyre® <u>vent-free</u> gas logs are used with your vent-free burner. |
| E. Using natural gas burner on propane gas or propane burner on natural gas | E. Make sure burner is set up for the gas you are using. Check nameplate attached to burner. Call your dealer immediately if nameplate does not match the gas you are using. |
| F. Adding any accessories to burner system | F. Shut down burner system and take off any accessories that do not belong with the system. |
| G. Blocked orifice(s) or air shutter(s) | G. Dust, lint, fibers, paper, spider webs, pet hair, etc. in the fireplace and on the burner assembly can affect the operation of the burner and the ODS pilot assembly. Clean out the debris and vacuum around burner for dust that may have accumulated over time. Vacuum the ODS pilot assembly and over the air shutter holes. Any blockages in this area will affect the operation of the ODS sensor. |
| H. Log placement | H. Some log sets have notches on the bottom front and rear logs to restrict any side-to-side movement. The log support/main burner brackets restrict any forward or backward movement. Make sure log set is placed in its proper position as instructed in the owner's manual, so there is no flame impingement on log set. |
| I. Too many embers on the ember burner (where fitted) | I. Remove any additional embers not included with your vent-free gas log set. Important: DO NOT ADD ANY ADDITIONAL EMBERS TO THIS LOG SET. ANY ADDITIONAL EMBERS MAY CAUSE UNSAFE OPERATION. |

10) ODS PILOT WILL NOT STAY LIT WHEN KNOB IS RELEASED

| | |
|-------------------------------------|--|
| A. Haven't held knob in long enough | A. Hold knob in for 1 minute and release. If the knob doesn't hold, contact your dealer for service (valve replace or new ODS). |
|-------------------------------------|--|

11) WHISTLING NOISE COMING FROM BURNER

| | |
|--|------------------------------------|
| A. Burner may be cold or may have not been used for a prolonged period of time | A. Allow burner to warm up on low. |
| B. Air in gas line | B. Contact your gas company. |
| C. Clogged air openings | C. Clean all air openings. |

12) POPPING NOISE COMING FROM BURNER

| | |
|-----------------------|--|
| A. Flash tube blocked | A. Clear flash tube of all obstructions, especially around the bottom. |
|-----------------------|--|

WARNING: If the gas quality is bad, the burners will produce soot and/or your pilot will not stay lit. Contact your gas company.

WARRANTY

PETERSON VENT-FREE DECORATIVE GAS APPLIANCE LIMITED WARRANTY

All Peterson vent-free ceramic refractory gas logs are **WARRANTED** for as long as you own them (lifetime).

All Peterson vent-free fiber ceramic gas logs are **WARRANTED** for **SEVEN (7) YEARS**.

All Peterson glass is **WARRANTED** for **TEN (10) YEARS**.

All Peterson vent-free burner component parts, except valves, ODS pilots, and controls, are **WARRANTED** for **TEN (10) YEARS**.

All Peterson valves, ODS pilots, and controls are covered by a **ONE (1) YEAR Limited Warranty (excluding batteries)**.

PLEASE KEEP A COPY OF YOUR SALES SLIP FOR PROOF OF PURCHASE

This warranty applies to the original purchaser and to single family residential use only. It commences from date of purchase, and is valid only with proof of purchase.

This warranty does not cover parts becoming defective through misuse, accidental damage, electrical damage, improper handling, storage, and/or installation. Product must be installed (and gas must be connected) as specified in the instructions or operator's manual, by a **qualified professional installer**. Accessories, parts, valves, remotes, etc., when used must be Peterson Co. product.

This warranty **does not** apply to rust, corrosion, oxidation, or discoloration, unless the affected component becomes inoperable. It **does not** cover labor or labor-related charges.

This warranty specifically excludes liability for **indirect, incidental, or consequential** damages. Some states do not allow the exclusion or limitation of incidental or consequential damages, so the above exclusion may not apply to you. This warranty gives you specified legal rights, and you may have other rights that may vary from state to state.

For additional information regarding this warranty, or to place a warranty claim, contact the R.H. Peterson dealer where the product was purchased.

**TO REGISTER YOUR PRODUCT ONLINE GO TO: WWW.RHPETERSON.COM,
AND CLICK ON PRODUCT REGISTRATION. THANK YOU FOR YOUR PURCHASE.**

WHEN USED IN THE COMMONWEALTH OF MASSACHUSETTS

**INSTALLATION OF THIS APPLIANCE MUST BE PERFORMED BY A MASSACHUSETTS
LICENSED PLUMBER OR GAS FITTER ONLY.**

**THE INSTALLATION OF THIS APPLIANCE MUST CONFORM TO THE BOARD OF FIRE
PREVENTION REGULATIONS 527 CMR 30.00 UNVENTED PROPANE OR NATURAL GAS-
FIRED SPACE HEATERS.**

**This vent-free gas appliance is designed for use in a standard wood-burning fireplace. It is designed
to be used with an external wall switch or external remote thermostatic control system. Models with
the suffix 12(P) or 01(P) are designed to be used with an external wall switch or an external remote
wall thermostatic control system.**

Quality Check

Date: _____

| | | | | | | |
|-----------------|-------|-------|------------|---------------------------|--------------|-------|
| Burner Orifices | Nat. | L.P. | Leak Test: | _____ | Model#: | _____ |
| Main: | _____ | _____ | Burn Test: | _____ | Serial#: | _____ |
| Other: | _____ | _____ | Gas Type: | <u>Nat.</u> / <u>L.P.</u> | Air Shutter: | _____ |
| | | | | | Inspector: | _____ |